

MELLI

222-00038

MELLI SD SURFACE MOUNTED WALL LUMINAIRE made of aluminium, black, similar to RAL 9005, polycarbonate cover beam 110°, light output indirect, with converter, max. 350mA, dimmability: DALI 2, Push, IP20



DRAWING

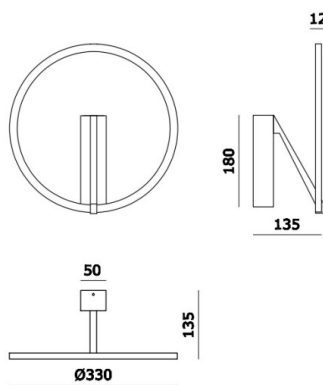

TECHNICAL DETAILS

System perform. [W]	15
Bulb type	LED
Luminous flux [lm]	490/520
Current sec. [mA]	350
Colour temp. [K]	2700/3000K
CRI	>90
Optics	polycarbonate cover
Converter	with converter
Light output	indirect
Beam angle [°]	110°
Voltage [V]	220-240V 50Hz
Material	aluminium
Height [mm]	135
Diameter [mm]	330
IP protection class	IP20
Voltage class	protection cl. I
Shock resistance	IK02
Net weight [kg]	0,80
Colour lamp	black
RAL	9005
EAN-Number	9010870324817
Lifetime [h]	L80 B10 50 000
Energy efficiency cl.	E
No. of luminaires B16A	61

LIGHT DISTRIBUTION CURVE

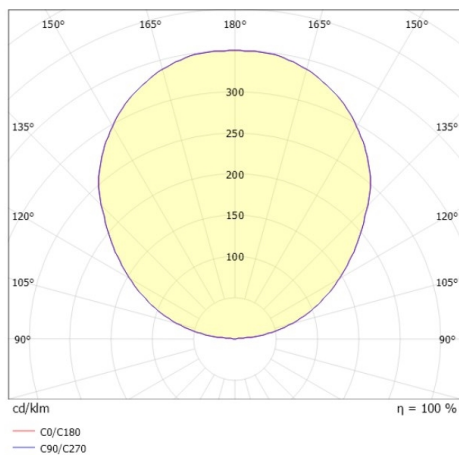

The values are rated values. Power and luminous flux are initially subject to a tolerance of +/- 10%. Colour temperature tolerance: +/- 150 K. The values apply to an ambient temperature of 25°C unless otherwise specified.