

REVER DINING

INSTALLATION INSTRUCTIONS | JULY 2022

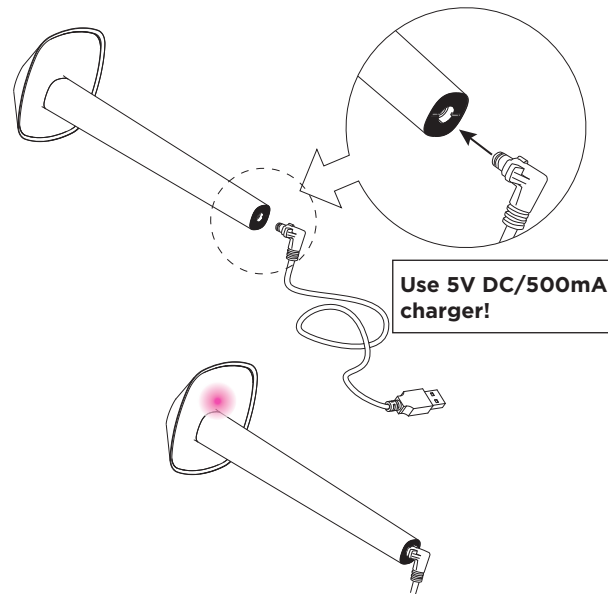

DIMENSIONS

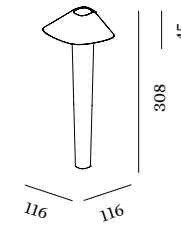

REVER DINING

POWER

The luminaire is powered by a built-in 3.7V/4000mA lithium battery. The luminaire is to be charged with a 5V DC/500mA constant voltage power supply. It takes 10 hours for the luminaire to be fully charged. The luminaire can work continuously for 8 hours after a full charging. During the charging process the luminaire is operational. Charge at least once every three months to maintain battery performance. Do not pull out the connector while the battery is charging as, this might damage the battery or reduce the life time of the battery.

INDICATOR LIGHTS

When charging the red LED indicator light is on. When charging is completed, the red LED indicator light goes off. When the voltage of the battery is too low (lower than 3.3V), the yellow LED indicator light is on. When the battery voltage is below 3.0V, the luminaire goes into sleep mode. When in sleep mode, the luminaire will not switch on and the yellow indicator light will flash 5 times.

SWITCH ON/OFF AND DIMMING

The touch switch and touch dimmer function is in the luminaire cover's metal top. The luminaire can be controlled (switching on/off and dimming) by touching the luminaire's top. Touch for 3 seconds to turn on the light. The brightness of the light will be as same as the previous time. When switched on, touch the luminaire's top for less than 1 second to change brightness in either low, middle or high output. Touch for 3 seconds to turn off the light.

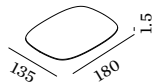

MAGNETIC
FLAT PLATE

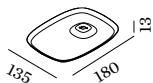

SINGLE CHARGING TRAY
WITH MAGNETIC FIX

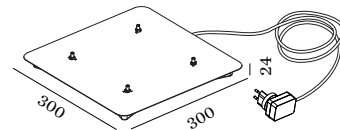

MULTIPLE CHARGER 4 PIECES

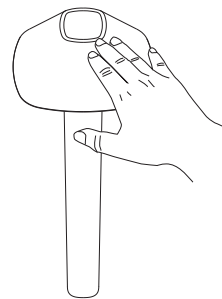

REVER DINING

INSTALLATION INSTRUCTIONS | JULY 2022

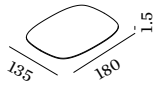

MAGNETIC FLAT PLATE

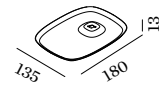
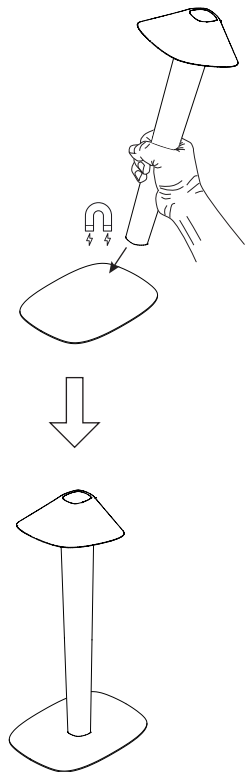

SINGLE CHARGING TRAY WITH MAGNETIC FIXATION

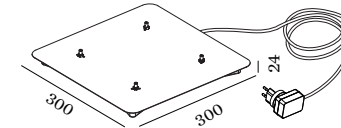
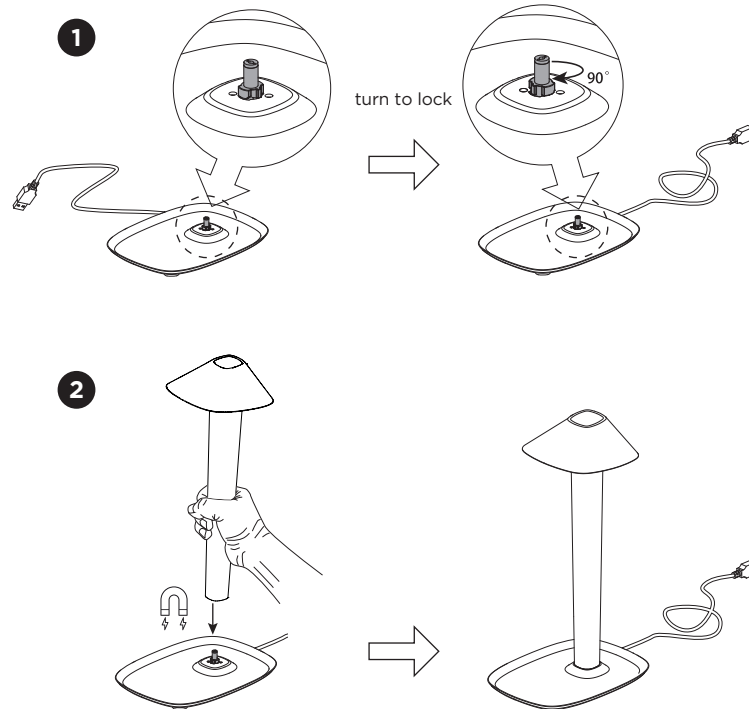

MULTIPLE CHARGER 4 PICES

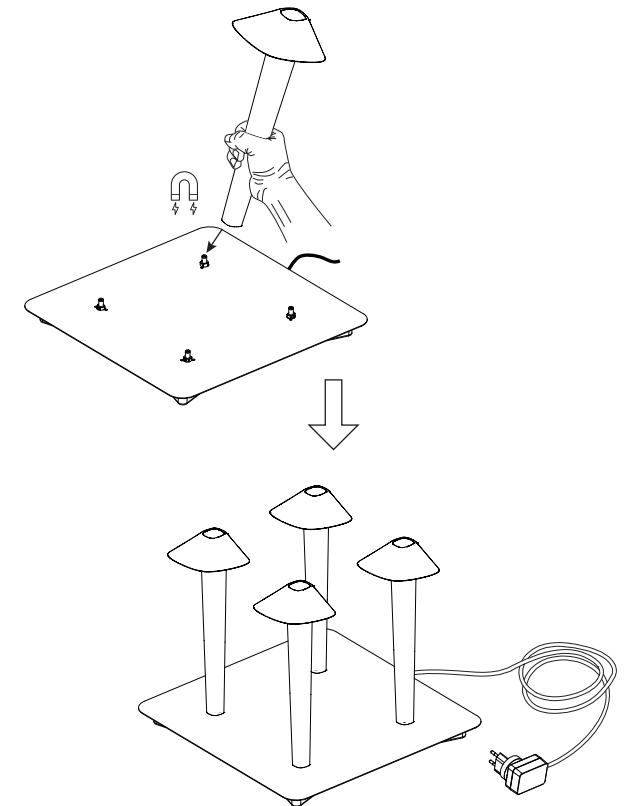

WEVER & DUCRÉ
LIGHTING

WEVER & DUCRÉ BV
Spinnerijstraat 99/21, 8500 Kortrijk, Belgium
weverducre.com

REVER DINING

INSTALLATION INSTRUCTIONS | JULY 2022

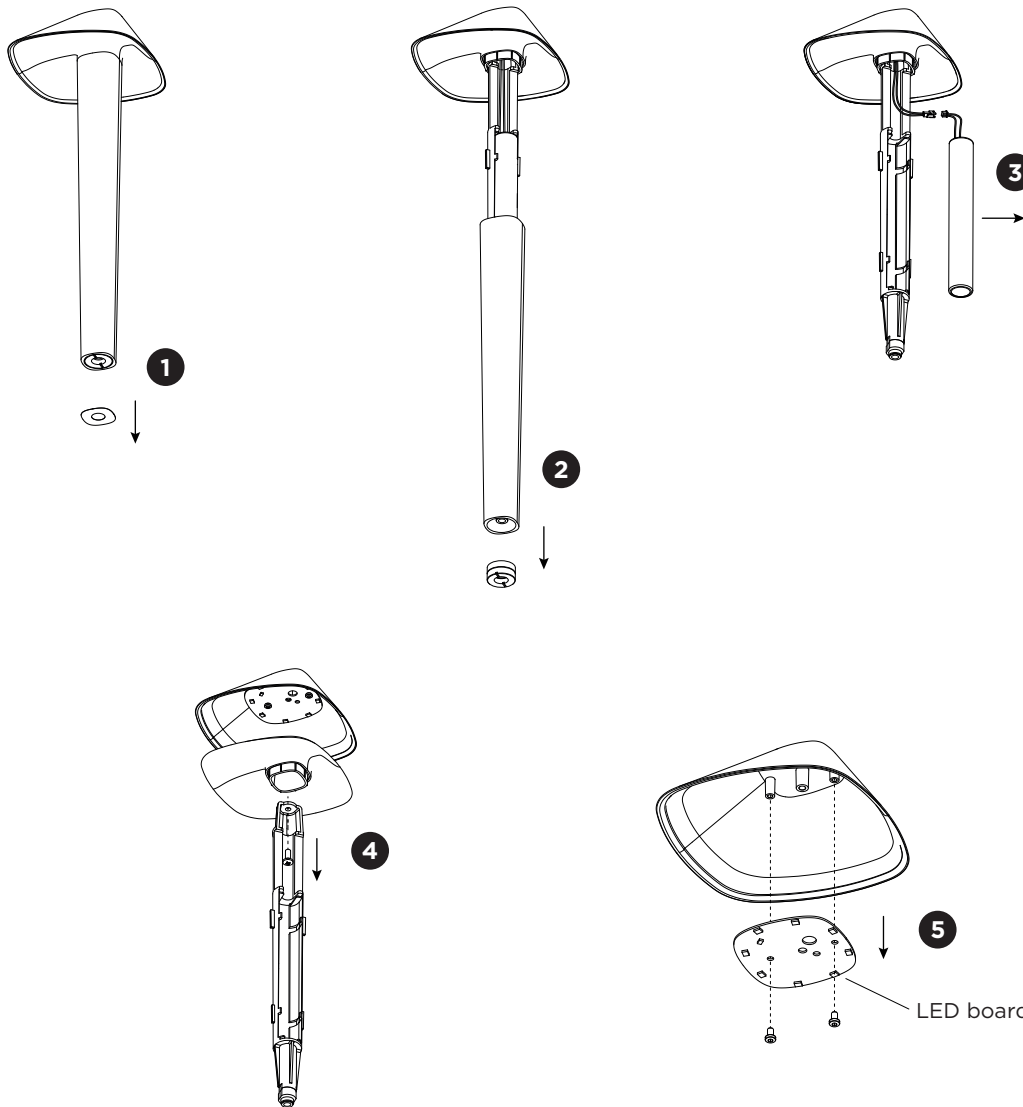

DISMOUNTING INSTRUCTION

Light source & battery

- 1 Remove the bottom pad.
- 2 Unscrew the magnet to remove the pole.
(possible to need a little force)
- 3 Cut off the cable tie and unplug the connector to remove the battery.
- 4 Unscrew the screw, remove the cable tie and remove the battery frame and diffuser.
- 5 Unscrew the LED board and cut the cables to remove it.

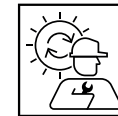

The light source is replaceable by an authorized professional.
For advice contact your Wever & Ducré customer service contact point.

This luminaire contains a light source with the corresponding energy class:

colour temperature	Energy class
2700K	A↑G F
2200K	A↑G G