

FEATURES

- 3 different sharp beam angles
- Wide variety of TM30 optimized LEDs
- ENEC approved drivers
- IEEE P1789 Flickerfree driver to 1%



LV 45° / 65°

COLOURS

Available colours:



Matt white RAL 9016 (XX=MW)
Matt black RAL 9005 (XX=BL)



LV 80° (on request)

SPRINGS

Standard with GS springs (concrete/gyproc).
Also available as above with
WS springs (gypro/metal).



Linea DS-FX 185 LV

Fixed

SPECIFICATIONS

Beam angle (FWHM)	45° / 65° (80° on request)
Fixture material	Die cast aluminium / Glass
Environment	Indoor
IP rate	IP20 / IP44
IK rate	IK09
Operating temperature (Ta)	-20°C / +45°C ¹
Safety marks	EN60598 / EN62031 / EN62471
EMC compliance	EN55015
Colour consistency (SDCM)	MacAdam step 3
Warranty	7 years * (within the European Union and the countries of the Free Trade Association for products delivered after 1 May 2015)
Energy class	These products contains a light source of energy efficiency class F (CRI97 3000K) / D (CRI80 3000K/4000K)

This luminaire contains built-in LED lamps. The lamps cannot be changed in the luminaire. EU 874/2012

¹ In applications with a flat roof (fi. car showrooms) the temperatures may exceed 45°C. Please ask our sales office for a special driver.



Ask our sales department about the possibilities for:
- Tunable white 2700-6500K.
- Extra LED options from the LUXEON Stylist Series

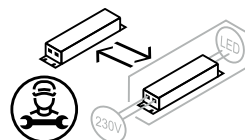
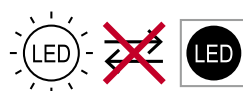

Only when the product is installed in a closed ceiling it may be exposed to water splashes, and only on its front side.



LINEA DS-FX 185 VARIATIONS

Linea DS-FX 185	CRI80	3000/4000K	3000/3400Lm	incl. power supply	page 3
Linea DS-FX 185	CRI80	3000/4000K	5000/5700Lm	incl. power supply	page 4
Linea DS-FX 185	CRI97	3000K	2500Lm	incl. power supply	page 5
Linea DS-FX 185	CRI97	3000K	3250/3750Lm	incl. power supply	page 6

CRI80/97 CHOOSE YOUR LV LUMEN OUTPUT

	mA	W	Lumen Output			Lumen / Watt			Driver types				
			CRI80	CRI80	CRI97	CRI80	CRI80	CRI97	No dim	Triac	1-10V&Push	Dali	Casambi
			3000K	4000K	3000K	3000K	4000K	3000K					
<i>Special request</i>	250	9,4	1200	1400	800	127	149	85	127570	x	126421	127576	x
<i>Special request</i>	350	13,2	1650	1900	1100	125	144	83	127570	x	127021	127576	127630
<i>Special request</i>	500	17,9	2250	2500	1450	125	139	81	127570	127032	127021	127576	127630
Standard	700	27,0	3000	3400	2150	111	126	80	127480N	122260	127021	127576	127630
<i>Special request</i>	800	32,1	3400	3750	2500	106	117	78	127484	on request	127021	127490	127630
<i>Special request</i>	900	35,5	3700	4100	2700	104	115	76	127484	on request	127021	127490	127630
<i>Special request</i>	1050	41,7	4200	4700	3000	101	113	72	127484	on request	127021	127490	127630
Standard	1200	50,5	5000	5700	3250 ¹	99	113	64	127690	on request	123170	123170	On request
Special request	1400	57,2	5600	6300	3750 ²	98	110	66	x	on request	123170	123170	On request

¹ For large downlights CRI97 No dim. ² For large downlights CRI97 1-10V and Dali

DIMENSIONS

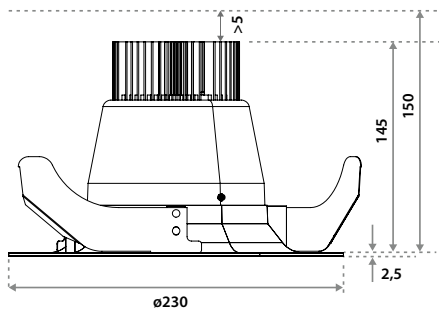

HOLE SIZE



Using GS springs: Ø 170-210 mm.
Thickness ceiling 8-173 mm & recess depth 173 mm. For plasterboard ceilings or similar harder materials. Turn the ring on the front counterclockwise after installation.



Using WS springs. Ø 170-210 mm.
Thickness ceiling 1-40 mm & recess depth 173 mm. For soft ceiling tiles we recommend using a wooden plate or a ceiling ring on the reverse side of the tile.

LINEA DS-FX 185 LV

CRI80 3000/3400LM

ITEM SPECIFICATIONS (PART A)

Description	Item code		UGR	Type	mA	Vf
	GS	WS				
Linea DS-FX LV 3000 Lm 3000K CRI80 45° No dim	1BNA03XXJE02	1BNA03XXJJ02	15.6	Incl. PSU	700	35,3
Linea DS-FX LV 3000 Lm 3000K CRI80 45° 1-10V & Push	1BNA03XXU202	1BNA03XXQ202	15.6	Incl. PSU	700	35,3
Linea DS-FX LV 3000 Lm 3000K CRI80 45° Dali	1BNA03XXV202	1BNA03XXR202	15.6	Incl. PSU	700	35,3
Linea DS-FX LV 3000 Lm 3000K CRI80 65° No dim	1BNA03XXJF02	1BNA03XXJK02	18.5	Incl. PSU	700	35,3
Linea DS-FX LV 3000 Lm 3000K CRI80 65° 1-10V & Push	1BNA03XXU302	1BNA03XXQ302	18.5	Incl. PSU	700	35,3
Linea DS-FX LV 3000 Lm 3000K CRI80 65° Dali	1BNA03XXV302	1BNA03XXR302	18.5	Incl. PSU	700	35,3
Linea DS-FX LV 3400 Lm 4000K CRI80 45° No dim	1BNA03XXJG02	1BNA03XXJL02	16.0	Incl. PSU	700	35,3
Linea DS-FX LV 3400 Lm 4000K CRI80 45° 1-10V & Push	1BNA03XXU402	1BNA03XXQ402	16.0	Incl. PSU	700	35,3
Linea DS-FX LV 3400 Lm 4000K CRI80 45° Dali	1BNA03XXV402	1BNA03XXR402	16.0	Incl. PSU	700	35,3
Linea DS-FX LV 3400 Lm 4000K CRI80 65° No dim	1BNA03XXJH02	1BNA03XXJM02	18.9	Incl. PSU	700	35,3
Linea DS-FX LV 3400 Lm 4000K CRI80 65° 1-10V & Push	1BNA03XXU502	1BNA03XXQ502	18.9	Incl. PSU	700	35,3
Linea DS-FX LV 3400 Lm 4000K CRI80 65° Dali	1BNA03XXV502	1BNA03XXR502	18.9	Incl. PSU	700	35,3

ITEM SPECIFICATIONS (PART B)

Description	W	Lm	Lm/W	CRI (typ.)	Pf	Ripple	Inrush current	B-16A Fuse	Safety class	Energy class
Linea DS-FX LV 3000 Lm 3000K CRI80 No dim	27,0	3000	111	82	0.95	<3%	5A 50µS	50 pcs	I	D
Linea DS-FX LV 3000 Lm 3000K CRI80 1-10V & Push	27,0	3000	111	82	0.95	<3%	5A 50µS	50 pcs	II	D
Linea DS-FX LV 3000 Lm 3000K CRI80 Dali	27,0	3000	111	82	0.95	<3%	5A 50µS	50 pcs	II	D
Linea DS-FX LV 3400 Lm 4000K CRI80 No dim	27,0	3400	126	82	0.95	<3%	5A 50µS	50 pcs	I	D
Linea DS-FX LV 3400 Lm 4000K CRI80 1-10V & Push	27,0	3400	126	82	0.95	<3%	5A 50µS	50 pcs	II	D
Linea DS-FX LV 3400 Lm 4000K CRI80 Dali	27,0	3400	126	82	0.95	<3%	5A 50µS	50 pcs	II	D

ITEM SPECIFICATIONS (PART C)

Description	Weight	Dimensions single carton	Quantity per carton	Expected lifespan B10 reported (25°C)		
				L70B10	L80B10	L90B10
Linea DS-FX LV CRI80	2005 gr	290x290x165 mm	120 pcs	>60.500 hrs	>60.500 hrs	>60.500 hrs

All values are measured at 230V (+/- 7%)

LINEA DS-FX 185 LV

CRI80 5000/5700LM

ITEM SPECIFICATIONS (PART A)

Description	Item code		UGR	Type	mA	Vf
	GS	WS				
Linea DS-FX LV 5000 Lm 3000K CRI80 45° No dim	1BNA03XXGK02	1BNA03XXEK02	17.4	Incl. PSU	1200	37,5
Linea DS-FX LV 5000 Lm 3000K CRI80 45° 1-10V & Push	1BNA03XXUU02	1BNA03XXQU02	17.4	Incl. PSU	1200	37,5
Linea DS-FX LV 5000 Lm 3000K CRI80 45° Dali	1BNA03XXVU02	1BNA03XXRU02	17.4	Incl. PSU	1200	37,5
Linea DS-FX LV 5000 Lm 3000K CRI80 65° No dim	1BNA03XXGL02	1BNA03XXEL02	20.3	Incl. PSU	1200	37,5
Linea DS-FX LV 5000 Lm 3000K CRI80 65° 1-10V & Push	1BNA03XXUV02	1BNA03XXQV02	20.3	Incl. PSU	1200	37,5
Linea DS-FX LV 5000 Lm 3000K CRI80 65° Dali	1BNA03XXVV02	1BNA03XXRV02	20.3	Incl. PSU	1200	37,5
Linea DS-FX LV 5700 Lm 4000K CRI80 45° No dim	1BNA03XXGM02	1BNA03XXEM02	17.8	Incl. PSU	1200	37,5
Linea DS-FX LV 5700 Lm 4000K CRI80 45° 1-10V & Push	1BNA03XXUW02	1BNA03XXQW02	17.8	Incl. PSU	1200	37,5
Linea DS-FX LV 5700 Lm 4000K CRI80 45° Dali	1BNA03XXVW02	1BNA03XXRW02	17.8	Incl. PSU	1200	37,5
Linea DS-FX LV 5700 Lm 4000K CRI80 65° No dim	1BNA03XXGN02	1BNA03XXEN02	20.7	Incl. PSU	1200	37,5
Linea DS-FX LV 5700 Lm 4000K CRI80 65° 1-10V & Push	1BNA03XXUX02	1BNA03XXQX02	20.7	Incl. PSU	1200	37,5
Linea DS-FX LV 5700 Lm 4000K CRI80 65° Dali	1BNA03XXVX02	1BNA03XXRX02	20.7	Incl. PSU	1200	37,5

ITEM SPECIFICATIONS (PART B)

Description	W	Lm	Lm/W	CRI (typ.)	Pf	Ripple	Inrush current	B-16A Fuse	Safety class	Energy class
Linea DS-FX LV 5000 Lm 3000K CRI80 No dim	50,5	5000	99	82	0.95	<3%	10A 200µS	30 pcs	II	D
Linea DS-FX LV 5000 Lm 3000K CRI80 1-10V & Push	50,5	5000	99	82	0.95	<3%	10A 200µS	30 pcs	I	D
Linea DS-FX LV 5000 Lm 3000K CRI80 Dali	50,5	5000	99	82	0.95	<3%	10A 200µS	30 pcs	I	D
Linea DS-FX LV 5700 Lm 4000K CRI80 No dim	50,5	5700	113	82	0.95	<3%	10A 200µS	30 pcs	II	D
Linea DS-FX LV 5700 Lm 4000K CRI80 1-10V & Push	50,5	5700	113	82	0.95	<3%	10A 200µS	30 pcs	I	D
Linea DS-FX LV 5700 Lm 4000K CRI80 Dali	50,5	5700	113	82	0.95	<3%	10A 200µS	30 pcs	I	D

ITEM SPECIFICATIONS (PART C)

Description	Weight	Dimensions single carton	Quantity per carton	Expected lifespan B10 reported (25°C)		
				L70B10	L80B10	L90B10
Linea DS-FX LV CRI80	2005 gr	290x290x165 mm	120 pcs	>60.500 hrs	>60.500 hrs	>60.500 hrs

All values are measured at 230V (+/- 7%)

LINEA DS-FX 185 LV

CRI97 2500LM

ITEM SPECIFICATIONS (PART A)

Description	Item code		UGR	Type	mA	Vf
	GS	WS				
Linea DS-FX LV 2500 Lm 3000K CRI97 45° No dim	1BNA03XXGX02	1BNA03XXEX02	15.0	Incl. PSU	800	35,3
Linea DS-FX LV 2500 Lm 3000K CRI97 45° 1-10V & Push	1BNA03XXU002	1BNA03XXQ002	15.0	Incl. PSU	800	35,3
Linea DS-FX LV 2500 Lm 3000K CRI97 45° Dali	1BNA03XXV002	1BNA03XXR002	15.0	Incl. PSU	800	35,3
Linea DS-FX LV 2500 Lm 3000K CRI97 65° No dim	1BNA03XXGY02	1BNA03XXEY02	17.9	Incl. PSU	800	35,3
Linea DS-FX LV 2500 Lm 3000K CRI97 65° 1-10V & Push	1BNA03XXU102	1BNA03XXQ102	17.9	Incl. PSU	800	35,3
Linea DS-FX LV 2500 Lm 3000K CRI97 65° Dali	1BNA03XXV102	1BNA03XXR102	17.9	Incl. PSU	800	35,3

ITEM SPECIFICATIONS (PART B)

Description	W	Lm	Lm/W	CRI (typ.)	Pf	Ripple	Inrush current	B-16A Fuse	Safety class	Energy class
Linea DS-FX LV 2500 Lm 3000K CRI97 No dim	32,1	2500	78	97	0.95	<3%	5A 50µS	50 pcs	I	F
Linea DS-FX LV 2500 Lm 3000K CRI97 1-10V & Push	32,1	2500	78	97	0.95	<3%	5A 50µS	50 pcs	II	F
Linea DS-FX LV 2500 Lm 3000K CRI97 Dali	32,1	2500	78	97	0.95	<3%	5A 50µS	50 pcs	II	F

ITEM SPECIFICATIONS (PART C)

Description	Weight	Dimensions single carton	Quantity per carton	Expected lifespan B10 reported (25°C)		
				L70B10	L80B10	L90B10
Linea DS-FX LV 2500 Lm 3000K CRI97	2005 gr	290x290x165 mm	120 pcs	>60.500 hrs	>60.500 hrs	>60.500 hrs

All values are measured at 230V (+/- 7%)

LINEA DS-FX 185 LV

CRI97 3750LM

ITEM SPECIFICATIONS (PART A)

Description	Item code		UGR	Type	mA	Vf
	GS	WS				
Linea DS-FX LV 3250 Lm 3000K CRI97 45° No dim	1BNA03XXGP02	1BNA03XXEP02	15.9	Incl. PSU	1200	37,5
Linea DS-FX LV 3750 Lm 3000K CRI97 45° 1-10V & Push	1BNA03XXUY02	1BNA03XXQY02	16.4	Incl. PSU	1400	37,5
Linea DS-FX LV 3750 Lm 3000K CRI97 45° Dali	1BNA03XXVY02	1BNA03XXRY02	16.4	Incl. PSU	1400	37,5
Linea DS-FX LV 3250 Lm 3000K CRI97 65° No dim	1BNA03XXGQ02	1BNA03XXEQ02	18.8	Incl. PSU	1200	37,5
Linea DS-FX LV 3750 Lm 3000K CRI97 65° 1-10V & Push	1BNA03XXUZ02	1BNA03XXQZ02	19.3	Incl. PSU	1400	37,5
Linea DS-FX LV 3750 Lm 3000K CRI97 65° Dali	1BNA03XXVZ02	1BNA03XXRZ02	19.3	Incl. PSU	1400	37,5

ITEM SPECIFICATIONS (PART B)

Description	W	Lm	Lm/W	CRI (typ.)	Pf	Ripple	Inrush current	B-16A Fuse	Safety class	Energy class
Linea DS-FX LV 3250 Lm 3000K CRI97 No dim	50,5	3250	64	97	0,95	<3%	10A 200µS	30 pcs	II	F
Linea DS-FX LV 3750 Lm 3000K CRI97 1-10V & Push	57,2	3750	66	97	0,95	<3%	10A 200µS	30 pcs	I	F
Linea DS-FX LV 3750 Lm 3000K CRI97 Dali	57,2	3750	66	97	0,95	<3%	10A 200µS	30 pcs	I	F

ITEM SPECIFICATIONS (PART C)

Description	Weight	Dimensions single carton	Quantity per carton	Expected lifespan B10 reported (25°C)		
				L70B10	L80B10	L90B10
Linea DS-FX LV 3250/3750 Lm 3000K CRI97	2005 gr	290x290x165 mm	120 pcs	>60.500 hrs	>60.500 hrs	>60.500 hrs

All values are measured at 230V (+/- 7%)

NEW STANDARDS REQUIRE NEW LEDS

TM-30 (new color norm): The Illuminating Engineering Society (IES) has published a new Technical Memorandum – TM-30-15 entitled “IES Method for Evaluating Light Source Color Rendition” – that promises to supplant CRI as a color metric. TM-30 relies on separate fidelity and gamut metrics, as well as a set of color samples that is more representative of real-world objects, as opposed to the pastel samples that were primarily used for the baseline CRI metric that was sometimes called Ra. The new color metric is intended to fairly and accurately characterize both LED-based solid-state lighting (SSL) and legacy sources.



Desaturated

CRI = 80 / R_g = 92



Red-Enhanced

CRI = 98 / R_g = 103

SPECIAL LEDS AVAILABLE

	CCT	CRI	R9	RF	RG	R15	TLCI	DOWNLIGHTS SMALL		DOWNLIGHTS LARGE		DOWNLIGHTS LARGE		ITEM CODE
								MA	LM	MA	LM	MA	LM	
CRI80	2700K	82	5	82	92	75	69	350 mA	1550	700 mA	2900	1200 mA	4800	51-4028-27-1
CRI80	3000K	82	5	81	93	75	66	350 mA	1625	700 mA	3000	1200 mA	5000	51-4028-30-1
CRI80	4000K	82	5	81	93	74	66	350 mA	1700	700 mA	3400	1200 mA	5700	51-4028-40-1
CRI97	2700K	97	93	96	103	99	97	350 mA	1150	800 mA	x	1400 mA	x	50-3031-27
CRI97	3000K	97	96	95	103	100	97	350 mA	1250	800 mA	2500	1400 mA	3750	50-3031-30
CRI97	4000K	97	96	95	103	100	97	350 mA	1350	800 mA	x	1400 mA	x	50-3031-40
CrispWhite	3000K	90	61	87	102	89	83	350 mA	780	900 mA	2300	1400 mA	3550	51-4029-30
Red Meat	1800K	82	81	77	119	95	60	350 mA	515	900 mA	1750	1400 mA	2350	51-4042-00
Bread & Pastries	2700K	92	54	89	96	86	91	350 mA	770	900 mA	2600	1400 mA	3500	51-4045-00



2700K

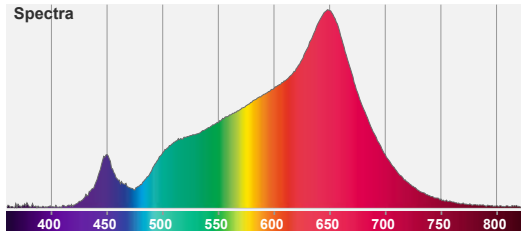
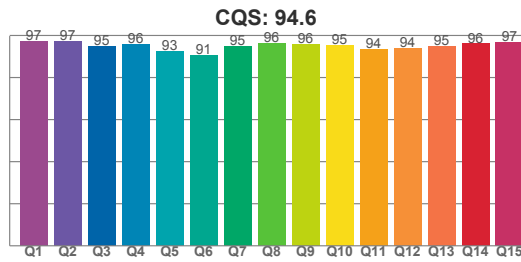
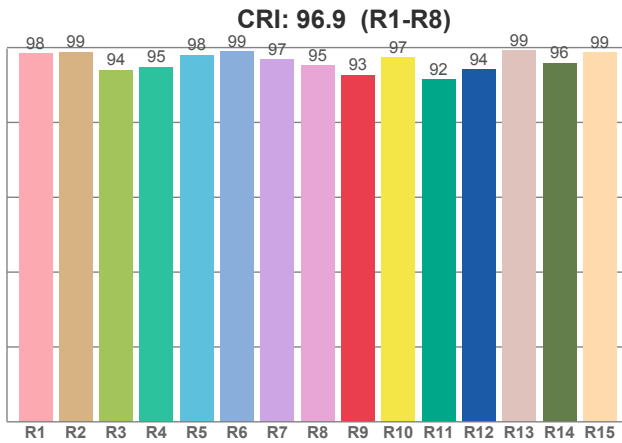

CCT	CRI	CRI R9	TM30 Rf	TM30 Rg	CQS
2700K	96.9	92.7	96.0	102.6	94.6

3000K

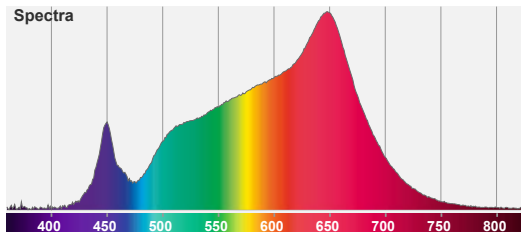
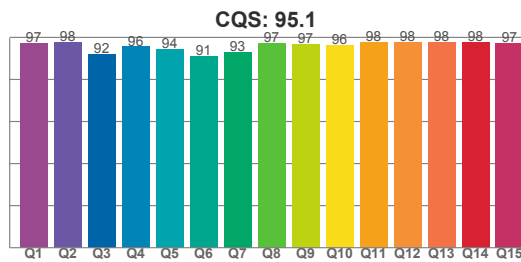
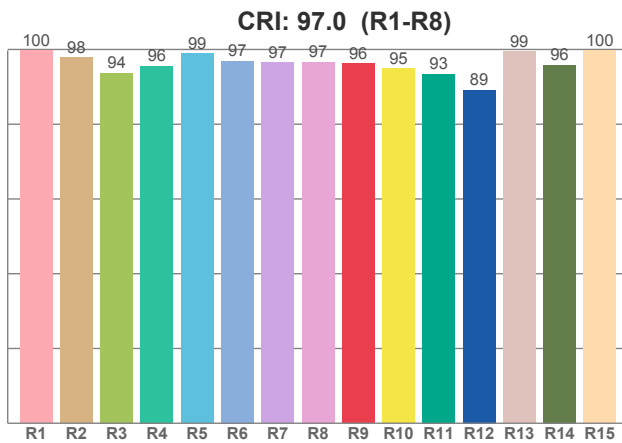

CCT	CRI	CRI R9	TM30 Rf	TM30 Rg	CQS
3000 K	97.0	96.2	95.0	103.3	95.1

4000K

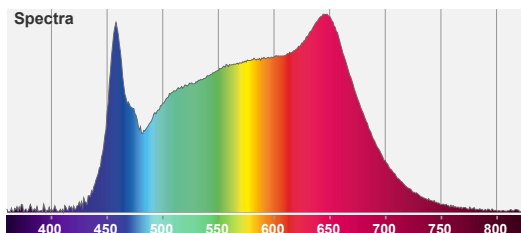
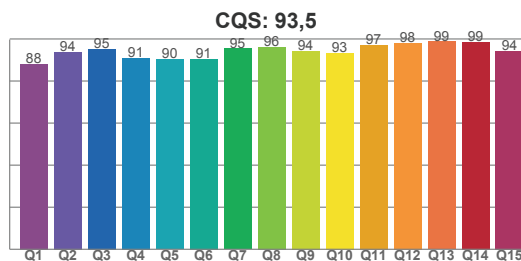
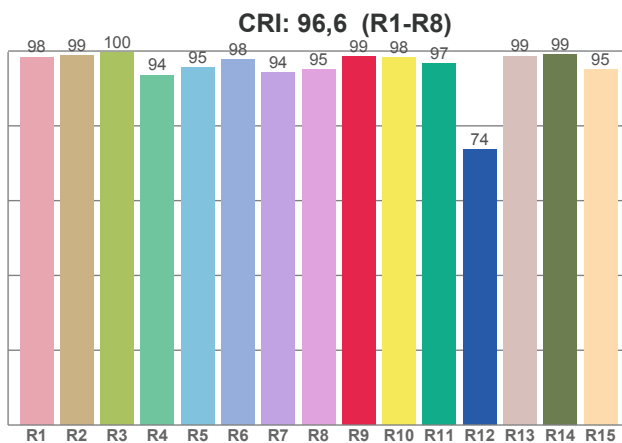

CCT	CRI	CRI R9	TM30 Rf	TM30 Rg	CQS
4000K	96.6	98.5	88.3	96.2	93.5