

FEATURES

- 3 different sharp beam angles
- Wide variety of TM30 optimized LEDs
- ENEC approved drivers
- IEEE P1789 Flickerfree driver to 1%



LV 45° / 65°

COLOURS

Available colours:



Matt white RAL 9016 (XX=MW)
Matt black RAL 9005 (XX=BL)



LV 80° (on request)



SPRINGS

Standard with GS springs (concrete/gypsum).
Also available as above with
WS springs (gypsum/metal).

Linea DS-FX 185 LV(-HE)

Fixed

SPECIFICATIONS

Beam angle (FWHM)	45° / 65° (80° on request)
Fixture material	Die cast aluminium / Glass
Environment	Indoor
IP rate	IP20 / IP44
IK rate	IK09
Operating temperature (Ta)	-20°C / +45°C ¹
Safety marks	EN60598 / EN62031 / EN62471
EMC compliance	EN55015
Colour consistency (SDCM)	MacAdam step 3
Warranty	7 years * (within the European Union and the countries of the Free Trade Association for products delivered after 1 May 2015)
Energy class	These products contains a light source of energy efficiency class: CR197 - F (3000K) & CR182 - E (3000K) / D (4000K)

This luminaire contains built-in LED lamps. The lamps cannot be changed in the luminaire. EU 874/2012

¹ In applications with a flat roof (fi. car showrooms) the temperatures may exceed 45°C. Please ask our sales office for a special driver.



Ask our sales department about the possibilities for:
- Tunable white 2700-6500K.
- High CRI LED options

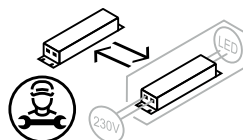

Only when the product is installed in a closed ceiling it may be exposed to water splashes, and only on its front side.



LINEA DS-FX 185 LV(-HE) VARIATIONS

Linea DS-FX 185 LV-HE	CRI82	3000/4000K	3575/3650Lm	incl. power supply	page 3
Linea DS-FX 185 LV-HE	CRI82	3000/4000K	5550/5800Lm	incl. power supply	page 4
Linea DS-FX 185 LV	CRI97	3000K	2500Lm	incl. power supply	page 5
Linea DS-FX 185 LV	CRI97	3000K	3250/3750Lm	incl. power supply	page 6

CRI82 CHOOSE YOUR LV LUMEN OUTPUT

	mA	W	Lumen Output		Lumen / Watt		UGR		Driver types				
			3000K	4000K	3000K	4000K	3000K		No dim	Triac	1-10V&Push	Dali	Casambi
							45°	65°					
Special request	250	9.2	1350	1400	147	152			CC21W150-500	x	126421	127576	x
Special request	350	13.1	1850	1900	141	145			CC21W150-500	x	127021	127576	127630
Special request	500	19.4	2525	2600	130	134			CC21W150-500	127032	127021	127576	127630
Standard	700	27.9	3575	3650	128	131	16.2	19.1	CC30W350-700	122260	127021	127576	127630
Special request	800	32.4	3825	4050	118	125			127484	on request	127021	127490	127630
Special request	900	36.8	4300	4500	117	122			127484	on request	127021	127490	127630
Special request	1050	43.7	4900	5100	112	117			127484	on request	127021	127490	127630
Standard	1200	51.2	5550	5800	108	113	17.7	20.6	127690	on request	123170	123170	On request

CRI97 CHOOSE YOUR LV LUMEN OUTPUT

	mA	W	Lumen Output		Lumen / Watt		UGR		Driver types				
			3000K	3000K	3000K	3000K	3000K		No dim	Triac	1-10V&Push	Dali	Casambi
							45°	65°					
Special request	250	9.4	800		85				CC21W150-500	x	126421	127576	x
Special request	350	13.2	1100		83				CC21W150-500	x	127021	127576	127630
Special request	500	17.9	1450		81				CC21W150-500	127032	127021	127576	127630
Special request	700	27.0	2150		80				CC30W350-700	122260	127021	127576	127630
Standard	800	32.1	2500		78		15.0	17.9	127484	on request	127021	127490	127630
Special request	900	35.5	2700		76				127484	on request	127021	127490	127630
Special request	1050	41.7	3000		72				127484	on request	127021	127490	127630
Standard	1200	50.5	3250 ¹		64		15.9	18.8	127690	on request	123170	123170	On request
Special request	1400	57.2	3750 ²		66		16.4	19.3	x	on request	123170	123170	On request

¹ For large downlights CRI97 No dim. ² For large downlights CR97 1-10V and Dali.

DIMENSIONS

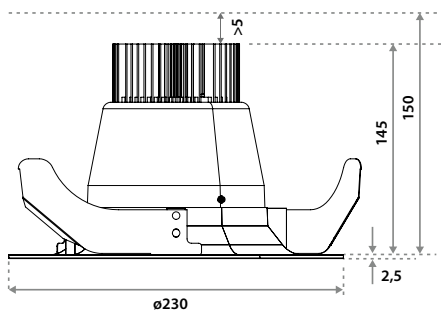

HOLE SIZE



Using GS springs: Ø 170-210 mm.
Thickness ceiling 8-173 mm & recess depth 173 mm. For plasterboard ceilings or similar harder materials. Turn the ring on the front counterclockwise after installation.



Using WS springs: Ø 170-210 mm.
Thickness ceiling 1-40 mm & recess depth 173 mm. For soft ceiling files we recommend using a wooden plate or a ceiling ring on the reverse side of the tile.

LINEA DS-FX 185 LV-HE

CRI82 3575/3650LM

ITEM SPECIFICATIONS (PART A)

Description	Item code		UGR	Type	mA	Vf
	GS	WS				
Linea DS-FX LV-HE 3575 Lm 3000K CRI82 45° No dim	1BN703XXJE02	1BN703XXJJ02	16.2	Incl. PSU	700	35,3
Linea DS-FX LV-HE 3575 Lm 3000K CRI82 45° 1-10V & Push	1BN703XXU202	1BN703XXQ202	16.2	Incl. PSU	700	35,3
Linea DS-FX LV-HE 3575 Lm 3000K CRI82 45° Dali	1BN703XXV202	1BN703XXR202	16.2	Incl. PSU	700	35,3
Linea DS-FX LV-HE 3575 Lm 3000K CRI82 65° No dim	1BN703XXJF02	1BN703XXJK02	19.1	Incl. PSU	700	35,3
Linea DS-FX LV-HE 3575 Lm 3000K CRI82 65° 1-10V & Push	1BN703XXU302	1BN703XXQ302	19.1	Incl. PSU	700	35,3
Linea DS-FX LV-HE 3575 Lm 3000K CRI82 65° Dali	1BN703XXV302	1BN703XXR302	19.1	Incl. PSU	700	35,3
Linea DS-FX LV-HE 3650 Lm 4000K CRI82 45° No dim	1BN703XXJG02	1BN703XXJL02	16.3	Incl. PSU	700	35,3
Linea DS-FX LV-HE 3650 Lm 4000K CRI82 45° 1-10V & Push	1BN703XXU402	1BN703XXQ402	16.3	Incl. PSU	700	35,3
Linea DS-FX LV-HE 3650 Lm 4000K CRI82 45° Dali	1BN703XXV402	1BN703XXR402	16.3	Incl. PSU	700	35,3
Linea DS-FX LV-HE 3650 Lm 4000K CRI82 65° No dim	1BN703XXJH02	1BN703XXJM02	19.2	Incl. PSU	700	35,3
Linea DS-FX LV-HE 3650 Lm 4000K CRI82 65° 1-10V & Push	1BN703XXU502	1BN703XXQ502	19.2	Incl. PSU	700	35,3
Linea DS-FX LV-HE 3650 Lm 4000K CRI82 65° Dali	1BN703XXV502	1BN703XXR502	19.2	Incl. PSU	700	35,3

ITEM SPECIFICATIONS (PART B)

Description	W	Lm	Lm/W	CRI (typ.)	Pf	Ripple	Inrush current	B-16A Fuse	Safety class	Energy class
Linea DS-FX LV-HE 3575 Lm 3000K CRI82 No dim	27,9	3575	128	82	0.95	<3%	5A 50µS	50 pcs	II	E
Linea DS-FX LV-HE 3575 Lm 3000K CRI82 1-10V & Push	27,9	3575	128	82	0.95	<3%	5A 50µS	50 pcs	II	E
Linea DS-FX LV-HE 3575 Lm 3000K CRI82 Dali	27,9	3575	128	82	0.95	<3%	5A 50µS	50 pcs	II	E
Linea DS-FX LV-HE 3650 Lm 4000K CRI82 No dim	27,9	3650	131	82	0.95	<3%	5A 50µS	50 pcs	II	D
Linea DS-FX LV-HE 3650 Lm 4000K CRI82 1-10V & Push	27,9	3650	131	82	0.95	<3%	5A 50µS	50 pcs	II	D
Linea DS-FX LV-HE 3650 Lm 4000K CRI82 Dali	27,9	3650	131	82	0.95	<3%	5A 50µS	50 pcs	II	D

ITEM SPECIFICATIONS (PART C)

Description	Weight	Dimensions single carton	Quantity per carton	Expected lifespan B10 reported (25°C)		
				L70B10	L80B10	L90B10
Linea DS-FX LV-HE CRI82	2005 gr	290x290x165 mm	120 pcs	>60.500 hrs	>60.500 hrs	>60.500 hrs

All values are measured at 230V (+/- 7%)

LINEA DS-FX 185 LV-HE

CRI82 5550/5800LM

ITEM SPECIFICATIONS (PART A)

Description	Item code		UGR	Type	mA	Vf
	GS	WS				
Linea DS-FX LV-HE 5550 Lm 3000K CRI82 45° No dim	1BN703XXGK02	1BN703XXEK02	17.7	Incl. PSU	1200	37,5
Linea DS-FX LV-HE 5550 Lm 3000K CRI82 45° 1-10V & Push	1BN703XXUU02	1BN703XXQU02	17.7	Incl. PSU	1200	37,5
Linea DS-FX LV-HE 5550 Lm 3000K CRI82 45° Dali	1BN703XXVU02	1BN703XXRU02	17.7	Incl. PSU	1200	37,5
Linea DS-FX LV-HE 5550 Lm 3000K CRI82 65° No dim	1BN703XXGL02	1BN703XXEL02	20.6	Incl. PSU	1200	37,5
Linea DS-FX LV-HE 5550 Lm 3000K CRI82 65° 1-10V & Push	1BN703XXUV02	1BN703XXQV02	20.6	Incl. PSU	1200	37,5
Linea DS-FX LV-HE 5550 Lm 3000K CRI82 65° Dali	1BN703XXVW02	1BN703XXRV02	20.6	Incl. PSU	1200	37,5
Linea DS-FX LV-HE 5800 Lm 4000K CRI82 45° No dim	1BN703XXGM02	1BN703XXEM02	17.9	Incl. PSU	1200	37,5
Linea DS-FX LV-HE 5800 Lm 4000K CRI82 45° 1-10V & Push	1BN703XXUW02	1BN703XXQW02	17.9	Incl. PSU	1200	37,5
Linea DS-FX LV-HE 5800 Lm 4000K CRI82 45° Dali	1BN703XXVW02	1BN703XXRW02	17.9	Incl. PSU	1200	37,5
Linea DS-FX LV-HE 5800 Lm 4000K CRI82 65° No dim	1BN703XXGN02	1BN703XXEN02	20.8	Incl. PSU	1200	37,5
Linea DS-FX LV-HE 5800 Lm 4000K CRI82 65° 1-10V & Push	1BN703XXUX02	1BN703XXQX02	20.8	Incl. PSU	1200	37,5
Linea DS-FX LV-HE 5800 Lm 4000K CRI82 65° Dali	1BN703XXVX02	1BN703XXRX02	20.8	Incl. PSU	1200	37,5

ITEM SPECIFICATIONS (PART B)

Description	W	Lm	Lm/W	CRI (typ.)	Pf	Ripple	Inrush current	B-16A Fuse	Safety class	Energy class
Linea DS-FX LV-HE 5550 Lm 3000K CRI82 No dim	51,2	5550	108	82	0.95	<3%	10A 200µS	30 pcs	II	E
Linea DS-FX LV-HE 5550 Lm 3000K CRI82 1-10V & Push	51,2	5550	108	82	0.95	<3%	10A 200µS	30 pcs	I	E
Linea DS-FX LV-HE 5550 Lm 3000K CRI82 Dali	51,2	5550	108	82	0.95	<3%	10A 200µS	30 pcs	I	E
Linea DS-FX LV-HE 5800 Lm 4000K CRI82 No dim	51,2	5800	113	82	0.95	<3%	10A 200µS	30 pcs	II	D
Linea DS-FX LV-HE 5800 Lm 4000K CRI82 1-10V & Push	51,2	5800	113	82	0.95	<3%	10A 200µS	30 pcs	I	D
Linea DS-FX LV-HE 5800 Lm 4000K CRI82 Dali	51,2	5800	113	82	0.95	<3%	10A 200µS	30 pcs	I	D

ITEM SPECIFICATIONS (PART C)

Description	Weight	Dimensions single carton	Quantity per carton	Expected lifespan B10 reported (25°C)		
				L70B10	L80B10	L90B10
Linea DS-FX LV-HE CRI82	2005 gr	290x290x165 mm	120 pcs	>60.500 hrs	>60.500 hrs	>60.500 hrs

All values are measured at 230V (+/- 7%)

LINEA DS-FX 185 LV

CRI97 2500LM

ITEM SPECIFICATIONS (PART A)

Description	Item code		UGR	Type	mA	Vf
	GS	WS				
Linea DS-FX LV 2500 Lm 3000K CRI97 45° No dim	1BNA03XXGX02	1BNA03XXEX02	15.0	Incl. PSU	800	35,3
Linea DS-FX LV 2500 Lm 3000K CRI97 45° 1-10V & Push	1BNA03XXU002	1BNA03XXQ002	15.0	Incl. PSU	800	35,3
Linea DS-FX LV 2500 Lm 3000K CRI97 45° Dali	1BNA03XXV002	1BNA03XXR002	15.0	Incl. PSU	800	35,3
Linea DS-FX LV 2500 Lm 3000K CRI97 65° No dim	1BNA03XXGY02	1BNA03XXEY02	17.9	Incl. PSU	800	35,3
Linea DS-FX LV 2500 Lm 3000K CRI97 65° 1-10V & Push	1BNA03XXU102	1BNA03XXQ102	17.9	Incl. PSU	800	35,3
Linea DS-FX LV 2500 Lm 3000K CRI97 65° Dali	1BNA03XXV102	1BNA03XXR102	17.9	Incl. PSU	800	35,3

ITEM SPECIFICATIONS (PART B)

Description	W	Lm	Lm/W	CRI (typ.)	Pf	Ripple	Inrush current	B-16A Fuse	Safety class	Energy class
Linea DS-FX LV 2500 Lm 3000K CRI97 No dim	32,1	2500	78	97	0.95	<3%	5A 50µS	50 pcs	I	F
Linea DS-FX LV 2500 Lm 3000K CRI97 1-10V & Push	32,1	2500	78	97	0.95	<3%	5A 50µS	50 pcs	II	F
Linea DS-FX LV 2500 Lm 3000K CRI97 Dali	32,1	2500	78	97	0.95	<3%	5A 50µS	50 pcs	II	F

ITEM SPECIFICATIONS (PART C)

Description	Weight	Dimensions single carton	Quantity per carton	Expected lifespan B10 reported (25°C)		
				L70B10	L80B10	L90B10
Linea DS-FX LV 2500 Lm 3000K CRI97	2005 gr	290x290x165 mm	120 pcs	>60.500 hrs	>60.500 hrs	>60.500 hrs

All values are measured at 230V (+/- 7%)

LINEA DS-FX 185 LV

CRI97 3750LM

ITEM SPECIFICATIONS (PART A)

Description	Item code		UGR	Type	mA	Vf
	GS	WS				
Linea DS-FX LV 3250 Lm 3000K CRI97 45° No dim	1BNA03XXGP02	1BNA03XXEP02	15.9	Incl. PSU	1200	37,5
Linea DS-FX LV 3750 Lm 3000K CRI97 45° 1-10V & Push	1BNA03XXUY02	1BNA03XXQY02	16.4	Incl. PSU	1400	37,5
Linea DS-FX LV 3750 Lm 3000K CRI97 45° Dali	1BNA03XXVY02	1BNA03XXRY02	16.4	Incl. PSU	1400	37,5
Linea DS-FX LV 3250 Lm 3000K CRI97 65° No dim	1BNA03XXGQ02	1BNA03XXEQ02	18.8	Incl. PSU	1200	37,5
Linea DS-FX LV 3750 Lm 3000K CRI97 65° 1-10V & Push	1BNA03XXUZ02	1BNA03XXQZ02	19.3	Incl. PSU	1400	37,5
Linea DS-FX LV 3750 Lm 3000K CRI97 65° Dali	1BNA03XXVZ02	1BNA03XXRZ02	19.3	Incl. PSU	1400	37,5

ITEM SPECIFICATIONS (PART B)

Description	W	Lm	Lm/W	CRI (typ.)	Pf	Ripple	Inrush current	B-16A Fuse	Safety class	Energy class
Linea DS-FX LV 3250 Lm 3000K CRI97 No dim	50,5	3250	64	97	0.95	<3%	10A 200µS	30 pcs	II	F
Linea DS-FX LV 3750 Lm 3000K CRI97 1-10V & Push	57,2	3750	66	97	0.95	<3%	10A 200µS	30 pcs	I	F
Linea DS-FX LV 3750 Lm 3000K CRI97 Dali	57,2	3750	66	97	0.95	<3%	10A 200µS	30 pcs	I	F

ITEM SPECIFICATIONS (PART C)

Description	Weight	Dimensions single carton	Quantity per carton	Expected lifespan B10 reported (25°C)		
				L70B10	L80B10	L90B10
Linea DS-FX LV 3250/3750 Lm 3000K CRI97	2005 gr	290x290x165 mm	120 pcs	>60.500 hrs	>60.500 hrs	>60.500 hrs

All values are measured at 230V (+/- 7%)

NEW STANDARDS REQUIRE NEW LEDS

TM-30 (new color norm): The Illuminating Engineering Society (IES) has published a new Technical Memorandum – TM-30-15 entitled “IES Method for Evaluating Light Source Color Rendition” – that promises to supplant CRI as a color metric. TM-30 relies on separate fidelity and gamut metrics, as well as a set of color samples that is more representative of real-world objects, as opposed to the pastel samples that were primarily used for the baseline CRI metric that was sometimes called Ra. The new color metric is intended to fairly and accurately characterize both LED-based solid-state lighting (SSL) and legacy sources.



Desaturated

CRI = 82 / R_g = 94



Red-Enhanced

CRI = 97 / R_g = 103

HIGH CRI LED OPTIONS

	CCT	CRI	R9	RF	RG	DOWNLIGHTS SMALL			DOWNLIGHTS LARGE		DOWNLIGHTS LARGE		BRAND	ITEM CODE
						MA	LM	LM/W	MA	LM	MA	LM		
CRI82	2700K	82	5	83	94	350	1650	128	700	3400	1200	5300	Bridgelux ksf	51-4087-27
CRI82	3000K	82	7	86	95	350	1725	134	700	3575	1200	5550	Bridgelux ksf	51-4087-30
CRI82	4000K	82	18	84	96	350	1750	136	700	3650	1200	5800	Bridgelux ksf	51-4087-40
CRI90	2700K	92	67	88	104	350	1550	118	700	3150	1200	4700	Bridgelux ksf	51-4088-27
CRI90	3000K	92	67	92	99	350	1600	122	700	3250	1200	4850	Bridgelux ksf	51-4088-30
CRI90	4000K	92	78	92	100	350	1625	124	700	3300	1200	4925	Bridgelux ksf	51-4088-40
CRI97	2700K	97	93	96	103	350	1150	83	800	2300	1400	3425	Lumileds	50-3031-27
CRI97	3000K	97	96	95	103	350	1250	91	800	2500	1400	3750	Lumileds	50-3031-30
CRI97	4000K	97	96	95	103	350	1350	98	800	2700	1400	4050	Lumileds	50-3031-40

2700K

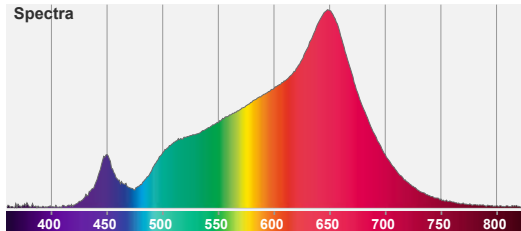
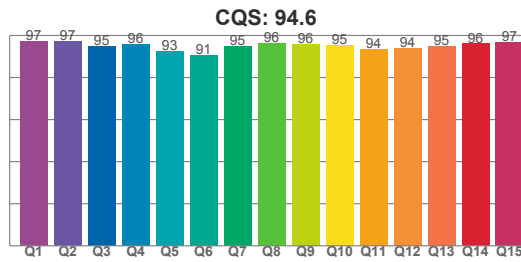
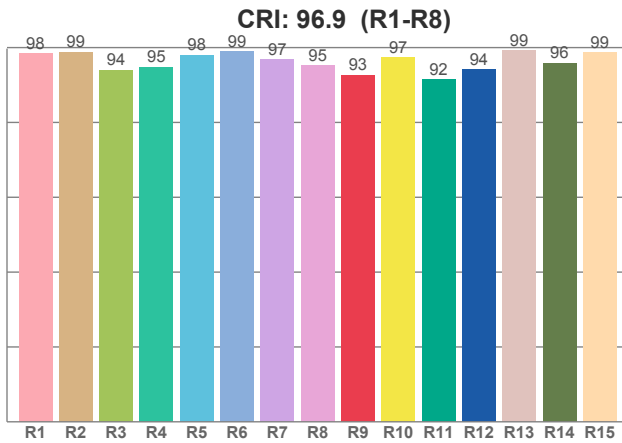

CCT	CRI	CRI R9	TM30 Rf	TM30 Rg	CQS
2700K	96.9	92.7	96.0	102.6	94.6

3000K

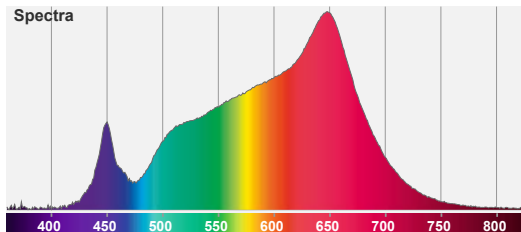
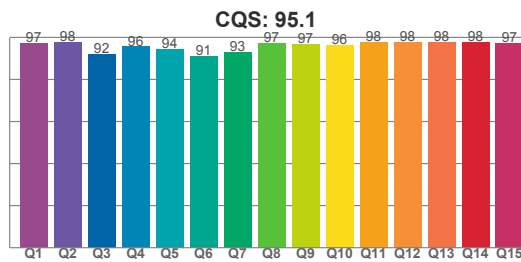
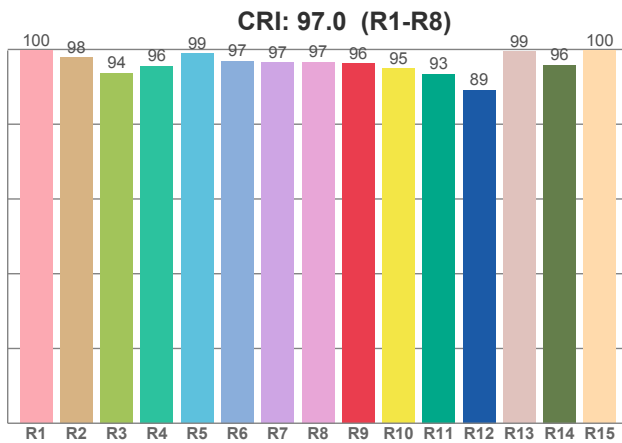

CCT	CRI	CRI R9	TM30 Rf	TM30 Rg	CQS
3000 K	97.0	96.2	95.0	103.3	95.1

4000K

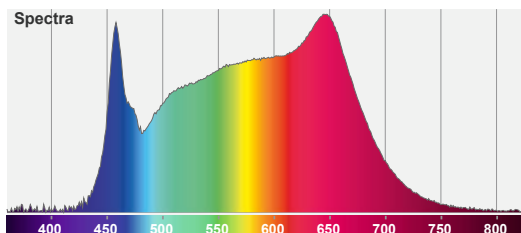
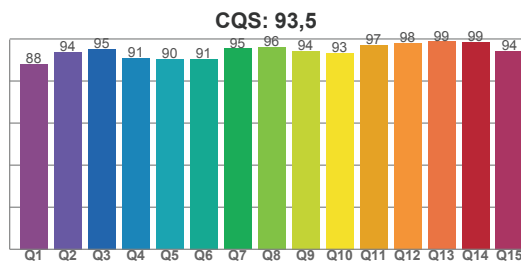
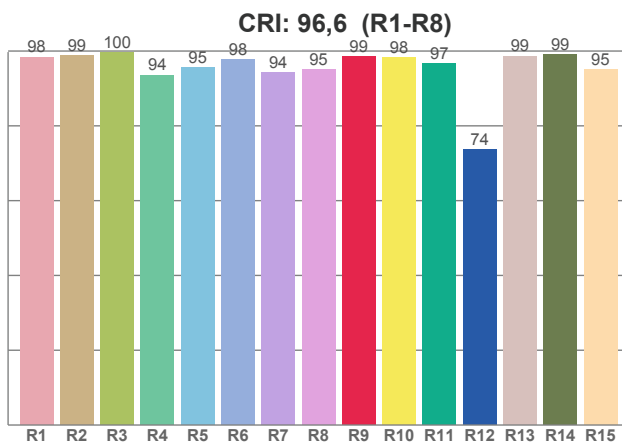

CCT	CRI	CRI R9	TM30 Rf	TM30 Rg	CQS
4000K	96.6	98.5	88.3	96.2	93.5