

### FEATURES

- 3 different sharp beam angles
- Wide variety of TM30 optimized LEDs
- ENEC approved drivers
- IEEE P1789 Flickerfree driver to 1%



### SPRINGS

Standard with CS springs (concrete/gyproc).  
Also available as above with  
WS springs (gypro/metal).

### COLOURS

Available colours:



Nr	Housing	Inside ring
RAL 9016		
XX=61	Matt white / Gold	
XX=63	Matt white / Silver	
XX=62	Matt white / Black	
XX=65	Matt white / White	



Nr	Housing	Inside ring
RAL 9005		
XX=71	Matt black / Gold	
XX=74	Matt black / Silver	
XX=72	Matt black / Black	
XX=76	Matt black / White	

## Strada 150 LV

Fixed

### SPECIFICATIONS

Beam angle (FWHM)	45° / 65° (80° on request)
Fixture material	Die cast aluminium / Glass
Environment	Indoor
IP rate	IP20 / IP44
IK rate	IK09
Operating temperature (Ta)	-20°C / +45°C <sup>1</sup>
Safety marks	EN60598 / EN62031 / EN62471
EMC compliance	EN55015
Colour consistency (SDCM)	MacAdam step 3
Warranty	7 years * (within the European Union and the countries of the Free Trade Association for products delivered after 1 May 2015)
Energy class	These products contains a light source of energy efficiency class F (CRI97 3000K) / D (CRI80 3000K/4000K)

This luminaire contains built-in LED lamps. The lamps cannot be changed in the luminaire. EU 874/2012

<sup>1</sup> In applications with a flat roof (fi. car showrooms) the temperatures may exceed 45°C. Please ask our sales office for a special driver.



Ask our sales department about the possibilities for:  
- Tunable white 2700-6500K.  
- Extra LED options from the LUXEON Stylist Series

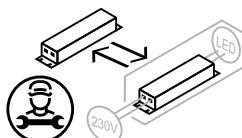
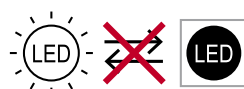

Only when the product is installed in a closed ceiling it may be exposed to water splashes, and only on its front side.



**STRADA 150 VARIATIONS**

Strada 150	CRI80	3000/4000K	3000/3400Lm	incl. power supply	page 3
Strada 150	CRI80	3000/4000K	5000/5700Lm	incl. power supply	page 4
Strada 150	CRI97	3000K	2500Lm	incl. power supply	page 5
Strada 150	CRI97	3000K	3250/3750Lm	incl. power supply	page 6

**CRI80/97 CHOOSE YOUR LV LUMEN OUTPUT**

	mA	W	Lumen Output			Lumen / Watt			Driver types				
			CRI80	CRI80	CRI97	CRI80	CRI80	CRI97	No dim	Triac	1-10V&Push	Dali	Casambi
			3000K	4000K	3000K	3000K	4000K	3000K					
<i>Special request</i>	250	9,4	1200	1400	800	127	149	85	127570	x	126421	127576	x
<i>Special request</i>	350	13,2	1650	1900	1100	125	144	83	127570	x	127021	127576	127630
<i>Special request</i>	500	17,9	2250	2500	1450	125	139	81	127570	127032	127021	127576	127630
<b>Standard</b>	700	27,0	3000	3400	2150	111	126	80	127480N	122260	127021	127576	127630
<i>Special request</i>	800	32,1	3400	3750	2500	106	117	78	127484	on request	127021	127490	127630
<i>Special request</i>	900	35,5	3700	4100	2700	104	115	76	127484	on request	127021	127490	127630
<i>Special request</i>	1050	41,7	4200	4700	3000	101	113	72	127484	on request	127021	127490	127630
<b>Standard</b>	1200	50,5	5000	5700	3250 <sup>1</sup>	99	113	64	127690	on request	123170	123170	On request
<b>Special request</b>	1400	57,2	5600	6300	3750 <sup>2</sup>	98	110	66	x	on request	123170	123170	On request

<sup>1</sup> For large downlights CRI97 No dim. <sup>2</sup> For large downlights CR97 1-10V and Dali

**DIMENSIONS**

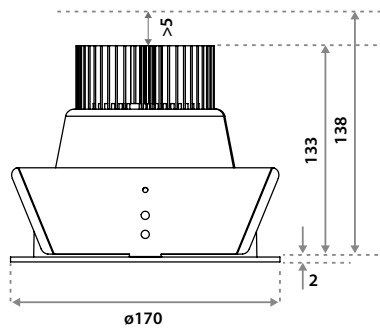

**HOLE SIZE**



**Using CS springs:** Ø 160 mm. Thickness ceiling 5-138 mm & recess depth 138 mm. For plasterboard ceilings or similar harder materials.



**Using WS springs.** Ø 150-165 mm. Thickness ceiling 1-35 mm & recess depth 138 mm. For soft ceiling tiles. We recommend using a ceiling ring on the reverse side of the tile.

**STRADA 150 LV**

**CRI80 3000/3400LM**

**ITEM SPECIFICATIONS (PART A)**

Description	Item code		UGR	Type	mA	Vf
	CS	WS				
Strada 150 LV 3000 Lm 3000K CRI80 45° No dim	850503XXJA02	850503XXJJ02	16.3	Incl. PSU	700	35,3
Strada 150 LV 3000 Lm 3000K CRI80 45° 1-10V & Push	850503XXN202	850503XXQ202	16.3	Incl. PSU	700	35,3
Strada 150 LV 3000 Lm 3000K CRI80 45° Dali	850503XXP202	850503XXR202	16.3	Incl. PSU	700	35,3
Strada 150 LV 3000 Lm 3000K CRI80 65° No dim	850503XXJB02	850503XXJK02	19.2	Incl. PSU	700	35,3
Strada 150 LV 3000 Lm 3000K CRI80 65° 1-10V & Push	850503XXN302	850503XXQ302	19.2	Incl. PSU	700	35,3
Strada 150 LV 3000 Lm 3000K CRI80 65° Dali	850503XXP302	850503XXR302	19.2	Incl. PSU	700	35,3
Strada 150 LV 3400 Lm 4000K CRI80 45° No dim	850503XXJC02	850503XXJL02	16.7	Incl. PSU	700	35,3
Strada 150 LV 3400 Lm 4000K CRI80 45° 1-10V & Push	850503XXN402	850503XXQ402	16.7	Incl. PSU	700	35,3
Strada 150 LV 3400 Lm 4000K CRI80 45° Dali	850503XXP402	850503XXR402	16.7	Incl. PSU	700	35,3
Strada 150 LV 3400 Lm 4000K CRI80 65° No dim	850503XXJD02	850503XXJM02	19.6	Incl. PSU	700	35,3
Strada 150 LV 3400 Lm 4000K CRI80 65° 1-10V & Push	850503XXN502	850503XXQ502	19.6	Incl. PSU	700	35,3
Strada 150 LV 3400 Lm 4000K CRI80 65° Dali	850503XXP502	850503XXR502	19.6	Incl. PSU	700	35,3

**ITEM SPECIFICATIONS (PART B)**

Description	W	Lm	Lm/W	CRI (typ.)	Pf	Ripple	Inrush current	B-16A Fuse	Safety class	Energy class
Strada 150 LV 3000 Lm 3000K CRI80 No dim	27,0	3000	111	82	0.95	<3%	5A 50µS	50 pcs	I	D
Strada 150 LV 3000 Lm 3000K CRI80 1-10V & Push	27,0	3000	111	82	0.95	<3%	5A 50µS	50 pcs	II	D
Strada 150 LV 3000 Lm 3000K CRI80 Dali	27,0	3000	111	82	0.95	<3%	5A 50µS	50 pcs	II	D
Strada 150 LV 3400 Lm 4000K CRI80 No dim	27,0	3400	126	82	0.95	<3%	5A 50µS	50 pcs	I	D
Strada 150 LV 3400 Lm 4000K CRI80 1-10V & Push	27,0	3400	126	82	0.95	<3%	5A 50µS	50 pcs	II	D
Strada 150 LV 3400 Lm 4000K CRI80 Dali	27,0	3400	126	82	0.95	<3%	5A 50µS	50 pcs	II	D

**ITEM SPECIFICATIONS (PART C)**

Description	Weight	Dimensions single carton	Quantity per carton	Expected lifespan B10 reported (25°C)		
				L70B10	L80B10	L90B10
Strada 150 LV CRI80	1100 gr	185x185x160 mm	12 pcs	>60.500 hrs	>60.500 hrs	>60.500 hrs

All values are measured at 230V (+/- 7%)

**STRADA 150 LV**

**CRI80 5000/5700LM**

**ITEM SPECIFICATIONS (PART A)**

Description	Item code		UGR	Type	mA	Vf
	CS	WS				
Strada 150 LV 5000 Lm 3000K CRI80 45° No dim	850503XXCK02	850503XXEK02	18.1	Incl. PSU	1200	37,5
Strada 150 LV 5000 Lm 3000K CRI80 45° 1-10V & Push	850503XXNU02	850503XXQU02	18.1	Incl. PSU	1200	37,5
Strada 150 LV 5000 Lm 3000K CRI80 45° Dali	850503XXPU02	850503XXRU02	18.1	Incl. PSU	1200	37,5
Strada 150 LV 5000 Lm 3000K CRI80 65° No dim	850503XXCL02	850503XXEL02	20.9	Incl. PSU	1200	37,5
Strada 150 LV 5000 Lm 3000K CRI80 65° 1-10V & Push	850503XXNV02	850503XXQV02	20.9	Incl. PSU	1200	37,5
Strada 150 LV 5000 Lm 3000K CRI80 65° Dali	850503XXPV02	850503XXRV02	20.9	Incl. PSU	1200	37,5
Strada 150 LV 5700 Lm 4000K CRI80 45° No dim	850503XXCM02	850503XXEM02	18.5	Incl. PSU	1200	37,5
Strada 150 LV 5700 Lm 4000K CRI80 45° 1-10V & Push	850503XXNW02	850503XXQW02	18.5	Incl. PSU	1200	37,5
Strada 150 LV 5700 Lm 4000K CRI80 45° Dali	850503XXPW02	850503XXRW02	18.5	Incl. PSU	1200	37,5
Strada 150 LV 5700 Lm 4000K CRI80 65° No dim	850503XXCN02	850503XXEN02	21.4	Incl. PSU	1200	37,5
Strada 150 LV 5700 Lm 4000K CRI80 65° 1-10V & Push	850503XXNX02	850503XXQX02	21.4	Incl. PSU	1200	37,5
Strada 150 LV 5700 Lm 4000K CRI80 65° Dali	850503XXPX02	850503XXRX02	21.4	Incl. PSU	1200	37,5

**ITEM SPECIFICATIONS (PART B)**

Description	W	Lm	Lm/W	CRI (typ.)	Pf	Ripple	Inrush current	B-16A Fuse	Safety class	Energy class
Strada 150 LV 5000 Lm 3000K CRI80 No dim	50,5	5000	99	82	0.95	<3%	10A 200µS	30 pcs	II	D
Strada 150 LV 5000 Lm 3000K CRI80 1-10V & Push	50,5	5000	99	82	0.95	<3%	10A 200µS	30 pcs	I	D
Strada 150 LV 5000 Lm 3000K CRI80 Dali	50,5	5000	99	82	0.95	<3%	10A 200µS	30 pcs	I	D
Strada 150 LV 5700 Lm 4000K CRI80 No dim	50,5	5700	113	82	0.95	<3%	10A 200µS	30 pcs	II	D
Strada 150 LV 5700 Lm 4000K CRI80 1-10V & Push	50,5	5700	113	82	0.95	<3%	10A 200µS	30 pcs	I	D
Strada 150 LV 5700 Lm 4000K CRI80 Dali	50,5	5700	113	82	0.95	<3%	10A 200µS	30 pcs	I	D

**ITEM SPECIFICATIONS (PART C)**

Description	Weight	Dimensions single carton	Quantity per carton	Expected lifespan B10 reported (25°C)		
				L70B10	L80B10	L90B10
Strada 150 LV CRI80	1100 gr	185x185x160 mm	12 pcs	>60.500 hrs	>60.500 hrs	>60.500 hrs

All values are measured at 230V (+/- 7%)

**STRADA 150 LV**

**CRI97 2500LM**

**ITEM SPECIFICATIONS (PART A)**

Description	Item code		UGR	Type	mA	Vf
	CS	WS				
Strada 150 LV 2500 Lm 3000K CRI97 45° No dim	850503XXCX02	850503XXEX02	15.7	Incl. PSU	800	35,3
Strada 150 LV 2500 Lm 3000K CRI97 45° 1-10V & Push	850503XXN002	850503XXQ002	15.7	Incl. PSU	800	35,3
Strada 150 LV 2500 Lm 3000K CRI97 45° Dali	850503XXP002	850503XXR002	15.7	Incl. PSU	800	35,3
Strada 150 LV 2500 Lm 3000K CRI97 65° No dim	850503XXCY02	850503XXEY02	18.5	Incl. PSU	800	35,3
Strada 150 LV 2500 Lm 3000K CRI97 65° 1-10V & Push	850503XXN102	850503XXQ102	18.5	Incl. PSU	800	35,3
Strada 150 LV 2500 Lm 3000K CRI97 65° Dali	850503XXP102	850503XXR102	18.5	Incl. PSU	800	35,3

**ITEM SPECIFICATIONS (PART B)**

Description	W	Lm	Lm/W	CRI (typ.)	Pf	Ripple	Inrush current	B-16A Fuse	Safety class	Energy class
Strada 150 LV 2500 Lm 3000K CRI97 No dim	32,1	2500	78	97	0.95	<3%	5A 50µS	50 pcs	I	F
Strada 150 LV 2500 Lm 3000K CRI97 1-10V & Push	32,1	2500	78	97	0.95	<3%	5A 50µS	50 pcs	II	F
Strada 150 LV 2500 Lm 3000K CRI97 Dali	32,1	2500	78	97	0.95	<3%	5A 50µS	50 pcs	II	F

**ITEM SPECIFICATIONS (PART C)**

Description	Weight	Dimensions single carton	Quantity per carton	Expected lifespan B10 reported (25°C)		
				L70B10	L80B10	L90B10
Strada 150 LV 2500 Lm 3000K CRI97	1100 gr	185x185x160 mm	12 pcs	>60.500 hrs	>60.500 hrs	>60.500 hrs

All values are measured at 230V (+/- 7%)

**STRADA 150 LV**

**CRI97 3750LM**

**ITEM SPECIFICATIONS (PART A)**

Description	Item code		UGR	Type	mA	Vf
	CS	WS				
Strada 150 LV 3250 Lm 3000K CRI97 45° No dim	850503XXCP02	850503XXEP02	16.6	Incl. PSU	1200	37,5
Strada 150 LV 3750 Lm 3000K CRI97 45° 1-10V & Push	850503XXNY02	850503XXQY02	17.1	Incl. PSU	1400	37,5
Strada 150 LV 3750 Lm 3000K CRI97 45° Dali	850503XXPY02	850503XXRY02	17.1	Incl. PSU	1400	37,5
Strada 150 LV 3250 Lm 3000K CRI97 65° No dim	850503XXCQ02	850503XXEQ02	19.4	Incl. PSU	1200	37,5
Strada 150 LV 3750 Lm 3000K CRI97 65° 1-10V & Push	850503XXNZ02	850503XXQZ02	19.9	Incl. PSU	1400	37,5
Strada 150 LV 3750 Lm 3000K CRI97 65° Dali	850503XXPZ02	850503XXRZ02	19.9	Incl. PSU	1400	37,5

**ITEM SPECIFICATIONS (PART B)**

Description	W	Lm	Lm/W	CRI (typ.)	Pf	Ripple	Inrush current	B-16A Fuse	Safety class	Energy class
Strada 150 LV 3250 Lm 3000K CRI97 No dim	50,5	3250	64	97	0.95	<3%	10A 200µS	30 pcs	II	F
Strada 150 LV 3750 Lm 3000K CRI97 1-10V & Push	57,2	3750	66	97	0.95	<3%	10A 200µS	30 pcs	I	F
Strada 150 LV 3750 Lm 3000K CRI97 Dali	57,2	3750	66	97	0.95	<3%	10A 200µS	30 pcs	I	F

**ITEM SPECIFICATIONS (PART C)**

Description	Weight	Dimensions single carton	Quantity per carton	Expected lifespan B10 reported (25°C)		
				L70B10	L80B10	L90B10
Strada 150 LV 3250/3750 Lm 3000K CRI97	1100 gr	185x185x160 mm	12 pcs	>60.500 hrs	>60.500 hrs	>60.500 hrs

All values are measured at 230V (+/- 7%)

**NEW STANDARDS REQUIRE NEW LEDS**

TM-30 (new color norm): The Illuminating Engineering Society (IES) has published a new Technical Memorandum – TM-30-15 entitled “IES Method for Evaluating Light Source Color Rendition” – that promises to supplant CRI as a color metric. TM-30 relies on separate fidelity and gamut metrics, as well as a set of color samples that is more representative of real-world objects, as opposed to the pastel samples that were primarily used for the baseline CRI metric that was sometimes called Ra. The new color metric is intended to fairly and accurately characterize both LED-based solid-state lighting (SSL) and legacy sources.



**Desaturated**

CRI = 80 / R<sub>g</sub> = 92



**Red-Enhanced**

CRI = 98 / R<sub>g</sub> = 103

**SPECIAL LEDS AVAILABLE**

	CCT	CRI	R9	RF	RG	R15	TLCI	DOWNLIGHTS SMALL		DOWNLIGHTS LARGE		DOWNLIGHTS LARGE		ITEM CODE
								MA	LM	MA	LM	MA	LM	
<b>CRI80</b>	2700K	82	5	82	92	75	69	350 mA	1550	700 mA	2900	1200 mA	4800	51-4028-27-1
<b>CRI80</b>	3000K	82	5	81	93	75	66	350 mA	1625	700 mA	3000	1200 mA	5000	51-4028-30-1
<b>CRI80</b>	4000K	82	5	81	93	74	66	350 mA	1700	700 mA	3400	1200 mA	5700	51-4028-40-1
<b>CRI97</b>	2700K	97	93	96	103	99	97	350 mA	1150	800 mA	x	1400 mA	x	50-3031-27
<b>CRI97</b>	3000K	97	96	95	103	100	97	350 mA	1250	800 mA	2500	1400 mA	3750	50-3031-30
<b>CRI97</b>	4000K	97	96	95	103	100	97	350 mA	1350	800 mA	x	1400 mA	x	50-3031-40
<b>CrispWhite</b>	3000K	90	61	87	102	89	83	350 mA	780	900 mA	2300	1400 mA	3550	51-4029-30
<b>Red Meat</b>	1800K	82	81	77	119	95	60	350 mA	515	900 mA	1750	1400 mA	2350	51-4042-00
<b>Bread &amp; Pastries</b>	2700K	92	54	89	96	86	91	350 mA	770	900 mA	2600	1400 mA	3500	51-4045-00



**2700K**

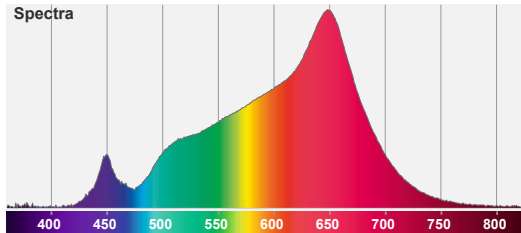
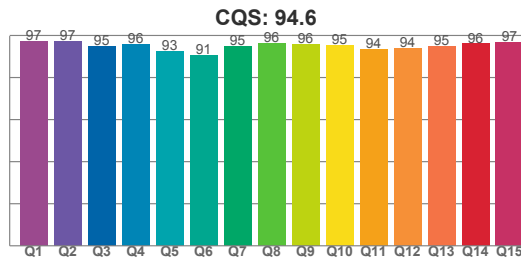
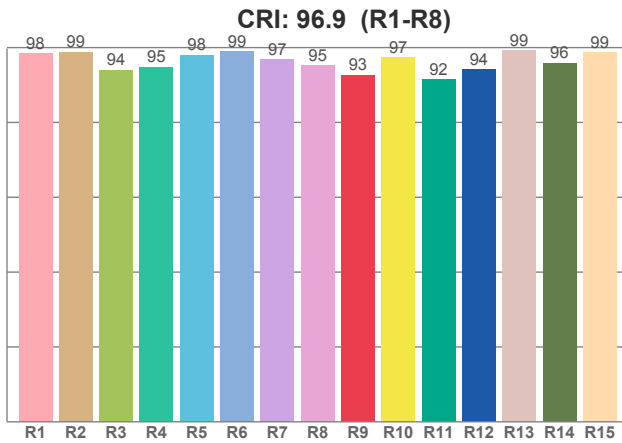

CCT	CRI	CRI R9	TM30 Rf	TM30 Rg	CQS
2700K	96.9	92.7	96.0	102.6	94.6

**3000K**

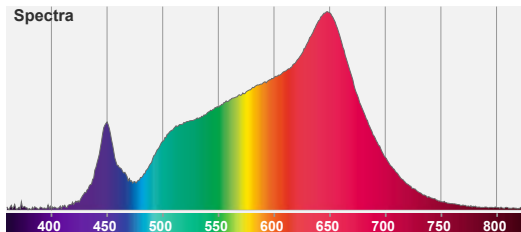
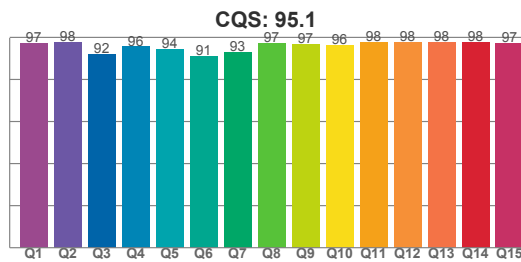
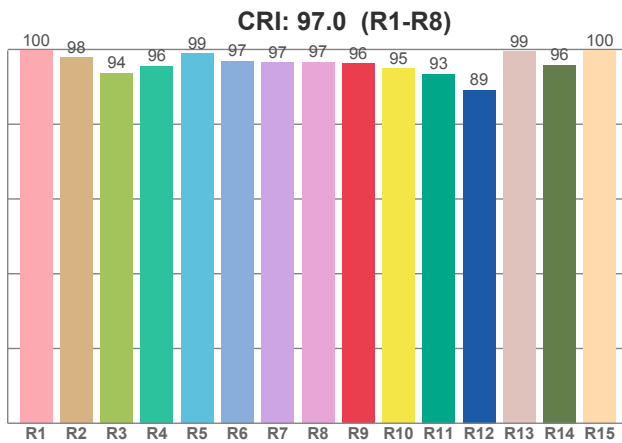

CCT	CRI	CRI R9	TM30 Rf	TM30 Rg	CQS
3000 K	97.0	96.2	95.0	103.3	95.1

**4000K**

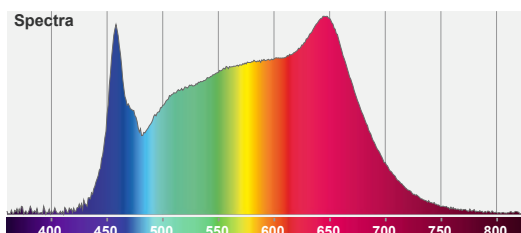
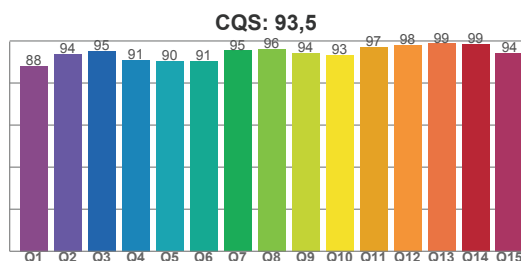
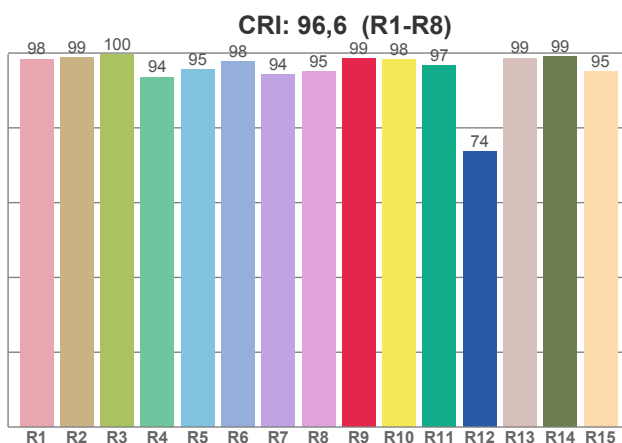

CCT	CRI	CRI R9	TM30 Rf	TM30 Rg	CQS
4000K	96.6	98.5	88.3	96.2	93.5