



## Rodina

# Lina45



Představte si lineární svítidlo, které dokáže uspokojit všechny vaše potřeby: splní UGR, má vysokou účinnost a sestavíte si ho dle svých přání. A navíc skvěle vypadá. Lina45 nabízí varianty s opálem, mikroprismou i optickou mřížkou, proto bez problému splní jak UGR pod 19 při světelném toku 4300 lm. Je skvělým řešením pro prostory pro náročné vizuální úkoly, protože v některých variantách splňuje dokonce UGR pod 16. Dosahuje také skvělých hodnot účinnosti až 170 lm/W. Nepřímou složku svícení zabezpečí varianta čirého plexi nebo do šířky svítící difusor (batwing distribution), který vytvoří rovnoměrnější osvětlení stropu.

Typ montáže	Přisazené, Závěsné
Typ vyzařování	Přímé, Přimo-nepřímé čirá nepřímá optika, Přimo-nepřímé batwing nepřímá optika
Barva svítidla	Černá, Stříbrná, Bílá
Teplota chromatičnosti	3000 K teplá bílá, 4000 K studená bílá
Materiál	Hliník
Světelný zdroj	LED MODUL
MacAdam zdroje	3
Zapojení svítidla	ON/OFF DALI ON/OFF + 1h nouze Další druhy stmívání ON/OFF + 3h nouze
Životnost	L80/B20 50 000 hodin
Záruka	5 let

## Variety svítidel rodiny Lina45

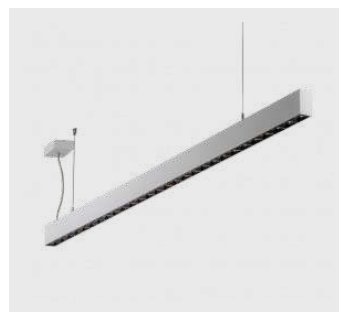

**Lina45**
**Montáž**
**Typ vyzařování**

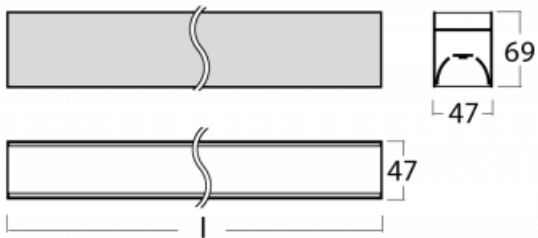
**Energetická třída**
**Certifikační značky**

Kód svítidla	Rozměry d/š/v (mm)	Příkon svítidla (W)	Světelný tok (lm)	Teplota chromatičnosti (K)	UGR
145-2C0K-10GEE/840, W	566 × 47 × 69	5.2	700	4000	< 24
145-2C0K-10GGE/840, W	566 × 47 × 69	8.5	1240	4000	< 26
145-2C0K-10GHE/840, W	566 × 47 × 69	13.1	1940	4000	< 27.6
145-2C0K-15GEE/840, W	847 × 47 × 69	7.4	1060	4000	< 24.1
145-2C0K-15GGE/840, W	847 × 47 × 69	12.2	1870	4000	< 26
145-2C0K-15GHE/840, W	847 × 47 × 69	19	2920	4000	< 27.6
145-2C0K-20GEE/840, W	1127 × 47 × 69	9	1410	4000	< 24.1
145-2C0K-20GGE/840, W	1127 × 47 × 69	15.8	2490	4000	< 26.1
145-2C0K-20GHE/840, W	1127 × 47 × 69	24.9	3890	4000	< 27.6
145-2C0K-25GEE/840, W	1408 × 47 × 69	10.9	1760	4000	< 24.1
145-2C0K-25GGE/840, W	1408 × 47 × 69	19.8	3110	4000	< 26.1
145-2C0K-25GHE/840, W	1408 × 47 × 69	31	4870	4000	< 27.6
145-2C0K-30GEE/840, W	1688 × 47 × 69	13.3	2120	4000	< 24.1
145-2C0K-30GGE/840, W	1688 × 47 × 69	23.4	3740	4000	< 26.1
145-2C0K-30GHE/840, W	1688 × 47 × 69	36.7	5840	4000	< 27.6
145-2C0K-35GEE/840, W	1969 × 47 × 69	15.3	2470	4000	< 24.1
145-2C0K-35GGE/840, W	1969 × 47 × 69	27	4360	4000	< 26.1
145-2C0K-35GHE/840, W	1969 × 47 × 69	42.4	6820	4000	< 27.6
145-2C0K-40GEE/840, W	2249 × 47 × 69	17.3	2830	4000	< 24.1
145-2C0K-40GGE/840, W	2249 × 47 × 69	30.5	4980	4000	< 26.1
145-2C0K-40GHE/840, W	2249 × 47 × 69	47.9	7790	4000	< 27.6

Uvedené kódy reprezentují bílé svítidlo s teplotou chromatičnosti 4000K a opálovým difuzorem.

**Poznámky**

Barva svítidla	
Teplota chromatičnosti	3000 K teplá bílá 4000 K studená bílá
Optický systém	Mikroprisma Opálový difusor
Zapojení svítidla	ON/OFF DALI ON/OFF + 1h nouze ON/OFF + 3h nouze
Ra	80

Svítidla jsou dodávána kompletní.

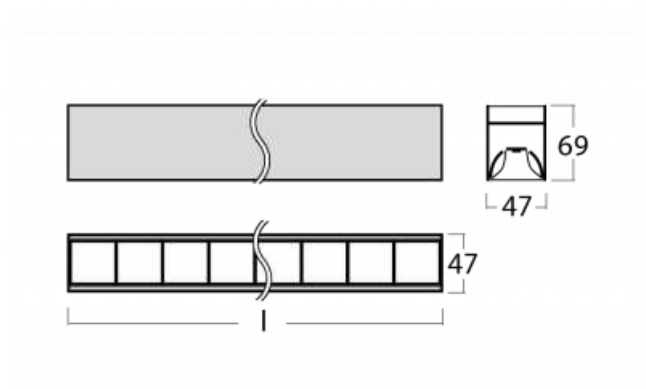
**Lina45**

**Montáž**

**Energetická třída**
**Typ vyzařování**

**Certifikační značky**

Kód svítidla	Rozměry d/š/v (mm)	Příkon svítidla (W)	Světelný tok (lm)	Teplota chromatičnosti (K)	UGR
145-2C0Z-10GEE/840, W	566 × 47 × 69	7.7	1070	4000	< 16.5
145-2C0Z-10GGE/840, W	566 × 47 × 69	9.7	1370	4000	< 17.4
145-2C0Z-10GHE/840, W	566 × 47 × 69	16.1	2250	4000	< 19.1
145-2C0Z-15GEE/840, W	847 × 47 × 69	11	1600	4000	< 16.5
145-2C0Z-15GGE/840, W	847 × 47 × 69	14.5	2060	4000	< 17.4
145-2C0Z-15GHE/840, W	847 × 47 × 69	24.1	3380	4000	< 19.1
145-2C0Z-20GEE/840, W	1127 × 47 × 69	14.7	2140	4000	< 16.5
145-2C0Z-20GGE/840, W	1127 × 47 × 69	18.5	2750	4000	< 17.4
145-2C0Z-20GHE/840, W	1127 × 47 × 69	32.3	4500	4000	< 19.1
145-2C0Z-25GEE/840, W	1408 × 47 × 69	18	2680	4000	< 16.5
145-2C0Z-25GGE/840, W	1408 × 47 × 69	24.2	3430	4000	< 17.4
145-2C0Z-25GHE/840, W	1408 × 47 × 69	39.2	5630	4000	< 19.1
145-2C0Z-30GEE/840, W	1688 × 47 × 69	21.1	3210	4000	< 16.5
145-2C0Z-30GGE/840, W	1688 × 47 × 69	28	4120	4000	< 17.4
145-2C0Z-30GHE/840, W	1688 × 47 × 69	46.3	6760	4000	< 19.1
145-2C0Z-35GEE/840, W	1969 × 47 × 69	25.5	3750	4000	< 16.5
145-2C0Z-35GGE/840, W	1969 × 47 × 69	32.2	4810	4000	< 17.4
145-2C0Z-35GHE/840, W	1969 × 47 × 69	53.1	7880	4000	< 19.1
145-2C0Z-40GEE/840, W	2249 × 47 × 69	28.4	4280	4000	< 16.5
145-2C0Z-40GGE/840, W	2249 × 47 × 69	36.5	5490	4000	< 17.4
145-2C0Z-40GHE/840, W	2249 × 47 × 69	61	9010	4000	< 19.1

Uvedené kódy reprezentují bílé svítidlo s teplotou chromatičnosti 4000K a plastovou mřížkou.

## Poznámky

Barva svítidla	● ● ●
Teplota chromatičnosti	3000 K teplá bílá 4000 K studená bílá
Optický systém	Plastová mřížka černá nízké UGR
Zapojení svítidla	ON/OFF DALI ON/OFF + 1h nouze ON/OFF + 3h nouze
Ra	80

Svítidla jsou dodávána kompletní.

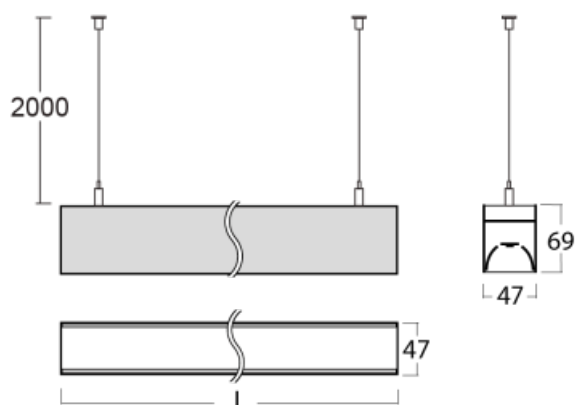
**Lina45**

**Montáž**

**Energetická třída**
**Typ vyzařování**

**Certifikační značky**

Kód svítidla	Rozměry d/š/v (mm)	Příkon svítidla (W)	Světelný tok (lm)	Teplota chromatičnosti (K)	UGR
145-5C0K-10GEE/840, W	566 × 47 × 69	5.2	700	4000	< 24
145-5B1K-10GEE/840, W	566 × 47 × 69	7.4	1040	4000	< 21.7
145-5C1K-10GEE/840, W	566 × 47 × 69	7.4	1060	4000	< 21.6
145-5C0K-10GGE/840, W	566 × 47 × 69	8.5	1240	4000	< 26
145-5B1K-10GGE/840, W	566 × 47 × 69	12.2	1830	4000	< 23.7
145-5C1K-10GGE/840, W	566 × 47 × 69	12.2	1870	4000	< 23.6
145-5C0K-10GHE/840, W	566 × 47 × 69	13.1	1940	4000	< 27.6
145-5B1K-10GHE/840, W	566 × 47 × 69	19.7	2860	4000	< 25.2
145-5C1K-10GHE/840, W	566 × 47 × 69	19.7	2920	4000	< 25.1
145-5C0K-15GEE/840, W	847 × 47 × 69	7.4	1060	4000	< 24.1
145-5C1K-15GEE/840, W	847 × 47 × 69	10.9	1770	4000	< 21.1
145-5B1K-15GEE/840, W	847 × 47 × 69	10.9	1720	4000	< 21.2
145-5C0K-15GGE/840, W	847 × 47 × 69	12.2	1870	4000	< 26.1
145-5C0K-15GHE/840, W	847 × 47 × 69	19	2920	4000	< 27.6
145-5B1K-15GGE/840, W	847 × 47 × 69	20.3	3040	4000	< 23.1
145-5C1K-15GGE/840, W	847 × 47 × 69	20.3	3120	4000	< 23
145-5B1K-15GHE/840, W	847 × 47 × 69	31.7	4750	4000	< 24.7
145-5C1K-15GHE/840, W	847 × 47 × 69	31.7	4870	4000	< 24.6
145-5C0K-20GEE/840, W	1127 × 47 × 69	9	1410	4000	< 24.1
145-5C1K-20GEE/840, W	1127 × 47 × 69	15.1	2480	4000	< 20.8
145-5B1K-20GEE/840, W	1127 × 47 × 69	15.1	2410	4000	< 21
145-5C0K-20GGE/840, W	1127 × 47 × 69	15.8	2490	4000	< 26.1
145-5C0K-20GHE/840, W	1127 × 47 × 69	24.9	3890	4000	< 27.6
145-5B1K-20GGE/840, W	1127 × 47 × 69	27.4	4250	4000	< 22.9
145-5C1K-20GGE/840, W	1127 × 47 × 69	27.4	4370	4000	< 22.8
145-5B1K-20GHE/840, W	1127 × 47 × 69	43.6	6640	4000	< 24.5
145-5C1K-20GHE/840, W	1127 × 47 × 69	43.6	6830	4000	< 24.3
145-5C0K-25GEE/840, W	1408 × 47 × 69	10.9	1760	4000	< 24.1
145-5C1K-25GEE/840, W	1408 × 47 × 69	19.5	3180	4000	< 20.7

145-5B1K-25GEE/840, W	1408 × 47 × 69	19.5	3100	4000	< 20.8
145-5C0K-25GGE/840, W	1408 × 47 × 69	19.8	3110	4000	< 26.1
145-5C0K-25GHE/840, W	1408 × 47 × 69	31	4870	4000	< 27.6
145-5B1K-25GGE/840, W	1408 × 47 × 69	35.3	5460	4000	< 22.8
145-5C1K-25GGE/840, W	1408 × 47 × 69	35.3	5620	4000	< 22.7
145-5B1K-25GHE/840, W	1408 × 47 × 69	55.7	8530	4000	< 24.3
145-5C1K-25GHE/840, W	1408 × 47 × 69	55.7	8780	4000	< 24.2
145-5C0K-30GEE/840, W	1688 × 47 × 69	13.3	2120	4000	< 24.1
145-5C1K-30GEE/840, W	1688 × 47 × 69	23.3	3890	4000	< 20.6
145-5B1K-30GEE/840, W	1688 × 47 × 69	23.3	3730	4000	< 20.7
145-5C0K-30GGE/840, W	1688 × 47 × 69	23.4	3740	4000	< 26.1
145-5C0K-30GHE/840, W	1688 × 47 × 69	36.7	5840	4000	< 27.6
145-5B1K-30GGE/840, W	1688 × 47 × 69	42.4	6670	4000	< 22.7
145-5C1K-30GGE/840, W	1688 × 47 × 69	42.4	6870	4000	< 22.6
145-5B1K-30GHE/840, W	1688 × 47 × 69	67.4	10420	4000	< 24.3
145-5C1K-30GHE/840, W	1688 × 47 × 69	67.4	10730	4000	< 24.1
145-5C0K-35GEE/840, W	1969 × 47 × 69	15.3	2470	4000	< 24.1
145-5C0K-35GGE/840, W	1969 × 47 × 69	27	4360	4000	< 26.1
145-5C1K-35GEE/840, W	1969 × 47 × 69	27.2	4600	4000	< 20.6
145-5B1K-35GEE/840, W	1969 × 47 × 69	27.2	4470	4000	< 20.7
145-5C0K-35GHE/840, W	1969 × 47 × 69	42.4	6820	4000	< 27.6
145-5B1K-35GGE/840, W	1969 × 47 × 69	49.5	7880	4000	< 22.6
145-5C1K-35GGE/840, W	1969 × 47 × 69	49.5	8110	4000	< 22.5
145-5B1K-35GHE/840, W	1969 × 47 × 69	78.7	12320	4000	< 24.2
145-5C1K-35GHE/840, W	1969 × 47 × 69	78.7	12680	4000	< 24.1
145-5C0K-40GEE/840, W	2249 × 47 × 69	17.3	2830	4000	< 24.1
145-5C1K-40GEE/840, W	2249 × 47 × 69	30.2	5310	4000	< 20.5
145-5B1K-40GEE/840, W	2249 × 47 × 69	30.2	5160	4000	< 20.7
145-5C0K-40GGE/840, W	2249 × 47 × 69	30.5	4980	4000	< 26.1
145-5C0K-40GHE/840, W	2249 × 47 × 69	47.9	7790	4000	< 27.6
145-5B1K-40GGE/840, W	2249 × 47 × 69	56.5	9090	4000	< 22.6



145-5C1K-40GGE/840, W	2249 × 47 × 69	56.5	9360	4000	< 22.5
145-5B1K-40GHE/840, W	2249 × 47 × 69	89.8	14210	4000	< 24.2
145-5C1K-40GHE/840, W	2249 × 47 × 69	89.8	14630	4000	< 24

Uvedené kódy reprezentují bílé svítidlo s teplotou chromatičnosti 4000K a opálovým difuzorem.

Poznámky	Barva svítidla	
	Teplota chromatičnosti	3000 K teplá bílá 4000 K studená bílá
	Optický systém	Mikroprisma Opálový difuzor
	Zapojení svítidla	ON/OFF DALI ON/OFF + 1h nouze ON/OFF + 3h nouze
	Ra	80

Svítidla jsou dodávána kompletní.

## Lina45

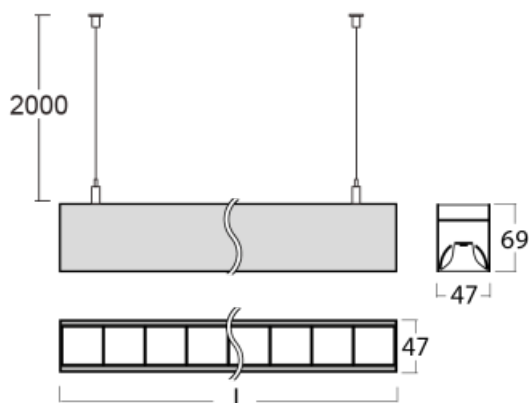

### Montáž



### Typ vyzařování



### Energetická třída

### Certifikační značky

Kód svítidla	Rozměry d/š/v (mm)	Příkon svítidla (W)	Světelný tok (lm)	Teplota chromatičnosti (K)	UGR
145-5C0Z-10GEE/840, W	566 × 47 × 69	7.7	1070	4000	< 16.5
145-5C0Z-10GGE/840, W	566 × 47 × 69	9.7	1370	4000	< 17.4
145-5C1Z-10GEE/840, W	566 × 47 × 69	9.9	1450	4000	< 13.1
145-5C1Z-10GGE/840, W	566 × 47 × 69	12.8	1820	4000	< 13.9
145-5C0Z-10GHE/840, W	566 × 47 × 69	16.1	2250	4000	< 19.1
145-5C1Z-10GHE/840, W	566 × 47 × 69	24.1	3440	4000	< 16.1
145-5C0Z-15GEE/840, W	847 × 47 × 69	11	1600	4000	< 16.5
145-5C0Z-15GGE/840, W	847 × 47 × 69	14.5	2060	4000	< 17.4
145-5C1Z-15GEE/840, W	847 × 47 × 69	16.1	2430	4000	< 12.6
145-5C1Z-15GGE/840, W	847 × 47 × 69	21.3	3050	4000	< 13.4
145-5C0Z-15GHE/840, W	847 × 47 × 69	24.1	3380	4000	< 19.1
145-5C1Z-15GHE/840, W	847 × 47 × 69	39.2	5750	4000	< 15.6
145-5C0Z-20GEE/840, W	1127 × 47 × 69	14.7	2140	4000	< 16.5
145-5C0Z-20GGE/840, W	1127 × 47 × 69	18.5	2750	4000	< 17.4
145-5B1Z-20GEE/840, W	1127 × 47 × 69	20.5	2910	4000	< 13.2
145-5C1Z-20GEE/840, W	1127 × 47 × 69	22.8	3410	4000	< 12.3
145-5B1Z-20GGE/840, W	1127 × 47 × 69	28.1	4150	4000	< 14.5
145-5C1Z-20GGE/840, W	1127 × 47 × 69	28.2	4280	4000	< 13.1
145-5C0Z-20GHE/840, W	1127 × 47 × 69	32.3	4500	4000	< 19.1
145-5B1Z-20GHE/840, W	1127 × 47 × 69	51.3	7250	4000	< 16.4
145-5C1Z-20GHE/840, W	1127 × 47 × 69	53.1	8060	4000	< 15.3
145-5C0Z-25GEE/840, W	1408 × 47 × 69	18	2680	4000	< 16.5
145-5C0Z-25GGE/840, W	1408 × 47 × 69	24.2	3430	4000	< 17.4
145-5B1Z-25GEE/840, W	1408 × 47 × 69	24.8	3720	4000	< 13.1
145-5C1Z-25GEE/840, W	1408 × 47 × 69	28.2	4390	4000	< 12.2
145-5C1Z-25GGE/840, W	1408 × 47 × 69	36	5500	4000	< 13
145-5B1Z-25GGE/840, W	1408 × 47 × 69	36.6	5330	4000	< 14.3
145-5C0Z-25GHE/840, W	1408 × 47 × 69	39.2	5630	4000	< 19.1
145-5B1Z-25GHE/840, W	1408 × 47 × 69	64.2	9300	4000	< 16.3

145-5C1Z-25GHE/840, W	1408 × 47 × 69	70.2	10370	4000	< 15.2
145-5C0Z-30GEE/840, W	1688 × 47 × 69	21.1	3210	4000	< 16.5
145-5C0Z-30GGE/840, W	1688 × 47 × 69	28	4120	4000	< 17.4
145-5B1Z-30GEE/840, W	1688 × 47 × 69	29.5	4530	4000	< 13
145-5C1Z-30GEE/840, W	1688 × 47 × 69	34.1	5370	4000	< 12.1
145-5B1Z-30GGE/840, W	1688 × 47 × 69	44	6520	4000	< 14.3
145-5C1Z-30GGE/840, W	1688 × 47 × 69	44.3	6730	4000	< 12.9
145-5C0Z-30GHE/840, W	1688 × 47 × 69	46.3	6760	4000	< 19.1
145-5B1Z-30GHE/840, W	1688 × 47 × 69	77.3	11340	4000	< 16.2
145-5C1Z-30GHE/840, W	1688 × 47 × 69	83.4	12690	4000	< 15.1
145-5C0Z-35GEE/840, W	1969 × 47 × 69	25.5	3750	4000	< 16.5
145-5C0Z-35GGE/840, W	1969 × 47 × 69	32.2	4810	4000	< 17.4
145-5B1Z-35GEE/840, W	1969 × 47 × 69	35.8	5340	4000	< 13
145-5C1Z-35GEE/840, W	1969 × 47 × 69	39.4	6350	4000	< 12
145-5C1Z-35GGE/840, W	1969 × 47 × 69	50.2	7960	4000	< 12.8
145-5B1Z-35GGE/840, W	1969 × 47 × 69	50.9	7700	4000	< 14.2
145-5C0Z-35GHE/840, W	1969 × 47 × 69	53.1	7880	4000	< 19.1
145-5B1Z-35GHE/840, W	1969 × 47 × 69	89.8	13380	4000	< 16.2
145-5C1Z-35GHE/840, W	1969 × 47 × 69	99.7	15000	4000	< 15
145-5C0Z-40GEE/840, W	2249 × 47 × 69	28.4	4280	4000	< 16.5
145-5C0Z-40GGE/840, W	2249 × 47 × 69	36.5	5490	4000	< 17.4
145-5B1Z-40GEE/840, W	2249 × 47 × 69	40.4	6150	4000	< 12.9
145-5C1Z-40GEE/840, W	2249 × 47 × 69	44.9	7330	4000	< 12
145-5C1Z-40GGE/840, W	2249 × 47 × 69	56.7	9190	4000	< 12.8
145-5B1Z-40GGE/840, W	2249 × 47 × 69	58.2	8890	4000	< 14.2
145-5C0Z-40GHE/840, W	2249 × 47 × 69	61	9010	4000	< 19.1
145-5B1Z-40GHE/840, W	2249 × 47 × 69	103.4	15430	4000	< 16.1
145-5C1Z-40GHE/840, W	2249 × 47 × 69	114.4	17310	4000	< 15









Uvedené kódy reprezentují bílé svítidlo s teplotou chromatičnosti 4000K a plastovou mřížkou.

## Poznámky



Barva svítidla	
Teplota chromatičnosti	3000 K teplá bílá 4000 K studená bílá
Optický systém	Plastová mřížka černá nízké UGR
Zapojení svítidla	ON/OFF DALI ON/OFF + 1h nouze Další druhy stmívání ON/OFF + 3h nouze
Ra	80

Svítidla jsou dodávána kompletní.

**Legenda**
**Typ montáže**

 Vestavné svítidlo	 Nástěnné svítidlo
 Polovestavné svítidlo	 Závěsné svítidlo
 Přisazené svítidlo	 Stojací svítidlo
 Lištové svítidlo	 Stolní svítidlo









**Typ vyzařování**

 Přímo svítící svítidlo
 Přímo-nepřímo svítící svítidlo
 Nepřímo svítící svítidlo

**Světelné zdroje**

 <b>Tunable White</b> nastavení teploty chromatičnosti	 <b>RealWhite</b> věrné zobrazení bílé barvy
 <b>RealColour</b> věrné zobrazení barev, Ra≥97	 <b>StrongColour</b> zvýraznění jedné barvy

**Symbody a značky**

 Svítidlo třídy I (přístupné vodivé části jsou připojeny na ochranný vodič)
 Svítidlo třídy II (ochrana před úrazem elektrickým proudem je založena na dvojité nebo zesílené izolaci)
 Svítidlo třídy III (ochrana před úrazem elektrickým proudem se zakládá na napájení bezpečným malým napětím SELV)
 Evropská značka shody, která vyjadřuje shodu vlastností výrobku se všemi harmonizovanými normami a předpisy Evropského společenství, které pro něj platí
 Svítidla jsou certifikována dle evropského systému ENEC
 Doporučená velikost montážního otvoru
 <b>IPxy</b> IP kód označující stupeň ochrany
 <b>EAC</b> Eurasijská značka shody

**11S-501I-20GGE/840, W**

11S-501I-20GGE/840, W

11S-501I-20GGE/840, W

11S-501I-20GGE/840, W











**Optický systém**
**Elektrické zapojení svítidla**
**Barevné provedení**
**Optický systém**

<b>B</b> Mikroprisma, nízké UGR	<b>L</b> Hladký hliníkový reflektor
<b>C</b> Čirý kryt	<b>M</b> Matná parabolická hliníková mřížka
<b>D</b> Asymetrický reflektor	<b>S</b> Úzký vyzařovací úhel – SPOT
<b>E</b> Leštěná parabolická hliníková mřížka, vyšší účinnost	<b>U</b> Střední vyzařovací úhel – MEDIUM
<b>F</b> Široký vyzařovací úhel – FLOOD	<b>W</b> Velmi široký vyzařovací úhel
<b>I</b> Mikroprisma	<b>Z</b> Plastová mřížka, nízké UGR
<b>K</b> Opálový difusor	



**Elektrické zapojení svítidla**

<b>/BT</b> Svítidla ovládaná pomocí technologie Bluetooth	<b>P</b> Čidlo a elektronický předřadník
<b>D</b> Stmívatelné DALI	<b>T</b> Stmívatelné tlačítkem
<b>E</b> Předřadník nestmívatelný	<b>TD</b> Stmívatelné DALI nebo tlačítkem
<b>M</b> Elektronický předřadník nestmívatelný s 1h nouzí	<b>U</b> Svítidlo stmívatelné s ovládáním na svítidle
<b>M3</b> Elektronický předřadník nestmívatelný s 3h nouzí	

**Barevné provedení**

<b>W</b>  RAL 9003	<b>B</b>  RAL 9005	<b>S</b>  TIGER 09/90530
<b>1021</b>  RAL 1021	<b>2000</b>  RAL 2000	<b>3020</b>  RAL 3020
<b>5015</b>  RAL 5015	<b>6018</b>  RAL 6018	<b>7016</b>  RAL 7016
<b>9006</b>  RAL 9006	<b>9010</b>  RAL 9010	

**Značky typu**

 <b>Smart</b> – Svítidlo nebo osvětlovací systém ovládaný pohybem, denním světlem nebo přes chytré zařízení pomocí Bluetooth
 <b>Acoustic</b> – Svítidla s akustickou výplní, která tlumí rušivý zvuk a zlepšuje akustiku v prostoru
 <b>Multiwatt</b> – Svítidla s individuálně nastavitelným světelným tokem pomocí speciální antény nebo mobilní aplikace

**UGR** UGR – Svítidla vhodná do kancelářských prostor