

PYRAMID

24-May-2019

1.0 LED

LED 7/10W | 350-500mA | COB 3-step | excl. power supply
 CE IP20 0.3m 36° 35°/35° 355°

white texture

113161W_

LIGHT COLOUR

2700K | >90CRI | 490/660lm | 18Vf 3
 3000K | >90CRI | 500/680lm | 18Vf 5
 1800-2850K | >95CRI | 310/410lm | 16Vf 9

ALWAYS USE

for power supplies see our catalogue

1.0 PAR16

PAR16 max. 12W | GU10 | 100-240VAC | 50-60Hz
 CE IP20 0.9m 35°/35° 355°

white texture

113120W0

OPTIONAL

for PAR16 lamps see our catalogue

side view

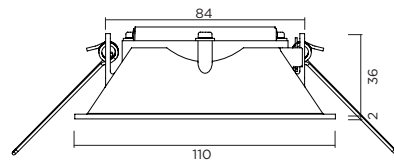

bottom view

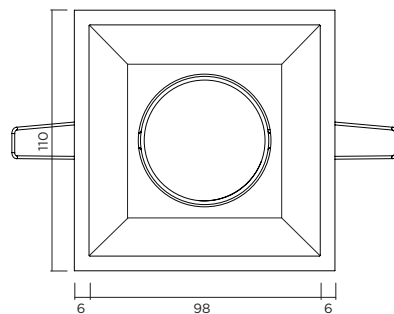

PYRAMID 1.0 LED

①



③

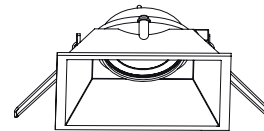

④

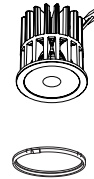

PYRAMID 1.0 PAR16

①



③

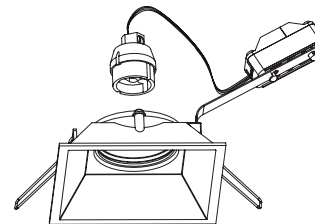

④



DIMENSIONS

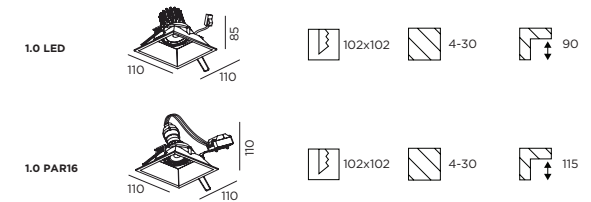

MOUNTING INSTRUCTION

- ① Make a hole in the ceiling according to the prescribed dimensions.

POWER CONNECTION

- ② SERIAL CONNECTION - for LED

Always use **POWER SUPPLY** according to the specifications of the LED-module

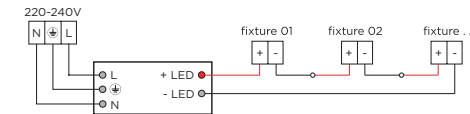

PARALLEL CONNECTION - for PAR16

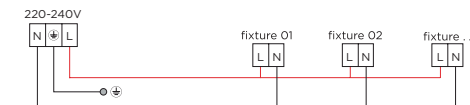

- ③ Insert the fixture in the hole
- ④ Place the LED engine or PAR16 lamp and fix with spring



WEVER & DUCRÉ
LIGHTING

www.weverducre.com

Wever & Ducré bvba Spinnerijstraat 99/21 8500 Kortrijk

**INSTALLATION
INSTRUCTIONS**