

# PYRAMID

24-May-2019

## 2.0 LED

**LED** 2xLED 7/10W | 350-500mA | COB 3-step | excl. power supply

CE IP20 960°C 0,3m 36° 35°/35° 355°

white texture

113261W

### LIGHT COLOUR

2700K | >90CRI | 2x490/660lm | 18Vf

3

3000K | >90CRI | 2x500/680lm | 18Vf

5

1800-2850K | >95CRI | 2x310/410lm | 16Vf

9

### ALWAYS USE

for power supplies see our catalogue

## 2.0 PAR16

2xPAR16 max. 12W | GU10 | 100-240VAC | 50-60Hz

CE IP20 960°C 0,9m 35°/35° 355°

white texture

113220W

### OPTIONAL

for PAR16 lamps see our catalogue

side view

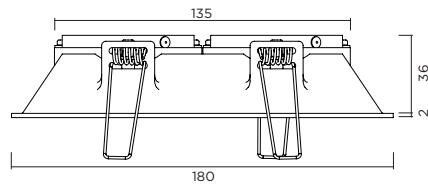

bottom view

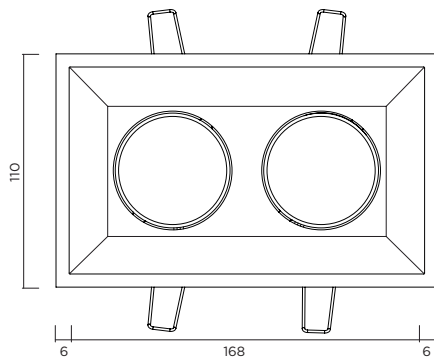

## PYRAMID 2.0 LED

①



③

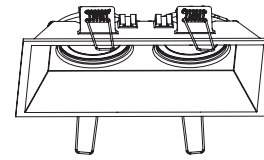

④

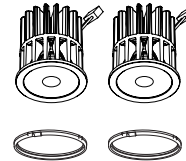

## PYRAMID 2.0 PAR16

①



③

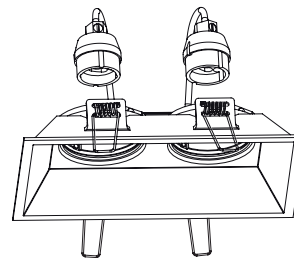

④

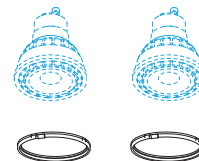

## DIMENSIONS

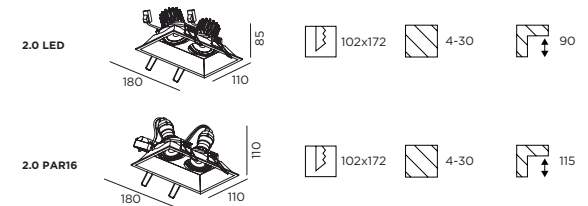

## MOUNTING INSTRUCTION

- ① Make a hole in the ceiling according to the prescribed dimensions.

## POWER CONNECTION

- ② SERIAL CONNECTION - for LED

**Always use POWER SUPPLY according to the specifications of the LED-module**

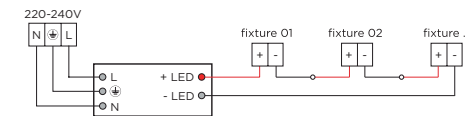

### PARALLEL CONNECTION - for PAR16

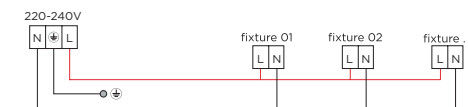

- ③ Insert the fixture in the hole
- ④ Place the LED engines or PAR16 lamps and fix with spring



**WEVER & DUCRÉ**  
LIGHTING

[www.weverducre.com](http://www.weverducre.com)

Wever & Ducre bvba Spinnerijstraat 99/21 8500 Kortrijk

**INSTALLATION  
INSTRUCTIONS**