

LITO

CEILING INSTALLATION
06-July-2018

1.0

LED 2/3W | 350-500mA | 6Vf | PCB 3-step | excl. power supply

CE IP20 0.3m 10 1 1

3000K | >80CRI | 160-210lm

white texture
aluminium anodised
black texture

145181W4
145181A4
145181B4

ALWAYS USE

for power supplies see our catalogue

2.0

LED 2/3W | 350-500mA | 6Vf | PCB 3-step | excl. power supply

CE IP20 0.3m 10 1 1

3000K | >80CRI | 160-210lm

white texture
aluminium anodised
black texture

145281W4
145281A4
145281B4

ALWAYS USE

for power supplies see our catalogue

LITO 1.0

①

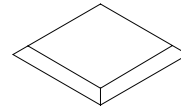

③

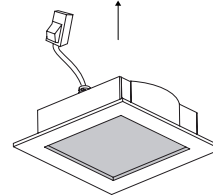

LITO 2.0

①

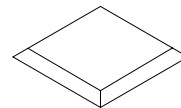

③

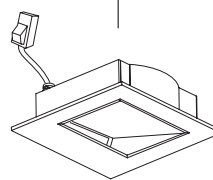

DIMENSIONS

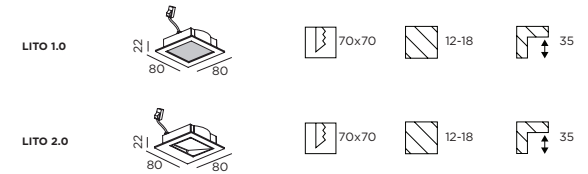

MOUNTING INSTRUCTION

- ① Make a hole in the ceiling according to the prescribed dimensions.

POWER CONNECTION

- ② SERIAL CONNECTION - for LED

**Always use POWER SUPPLY
350mA / 500mA**

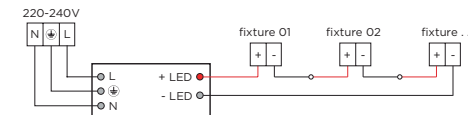

LITO

WALL INSTALLATION
06-July-2018

1.0

LED 2/3W | 350-500mA | 6Vf | PCB 3-step | excl. power supply

CE IP20 0.3m 10 10 10 10

3000K | >80CRI | 160-210lm

white texture	145181W4
aluminium anodised	145181A4
black texture	145181B4

ALWAYS USE
for power supplies see our catalogue

OPTIONAL (when using recessed housing, ALWAYS use plaster kit too)

plaster kit	90017119
recessed housing (always use in combination with plaster kit 90017119)	90012027

2.0

LED 2/3W | 350-500mA | 6Vf | PCB 3-step | excl. power supply

CE IP20 0.3m 10 10 10 10

3000K | >80CRI | 160-210lm

white texture	145281W4
aluminium anodised	145281A4
black texture	145281B4

ALWAYS USE
for power supplies see our catalogue

OPTIONAL (when using recessed housing, ALWAYS use plaster kit too)

plaster kit	90017119
recessed housing (always use in combination with plaster kit 90017119)	90012027

plaster kit
90017119 (OPTIONAL)

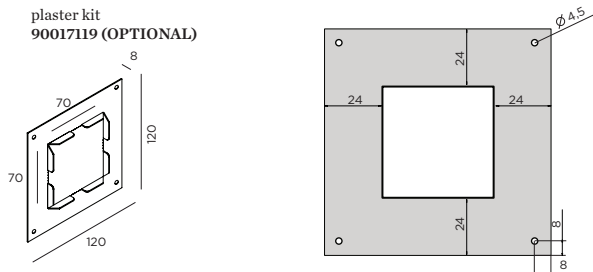

recessed housing (always use in combination with plaster kit)

90012027 (OPTIONAL)



standard

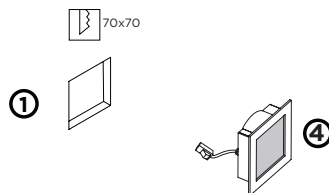

only with plaster kit

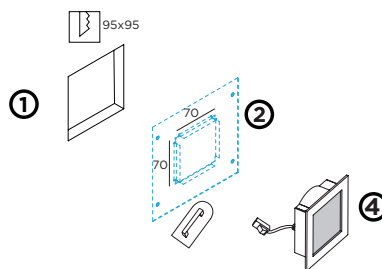

recessed housing + plaster kit

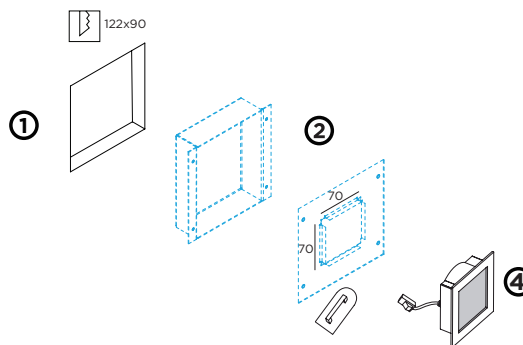

DIMENSIONS

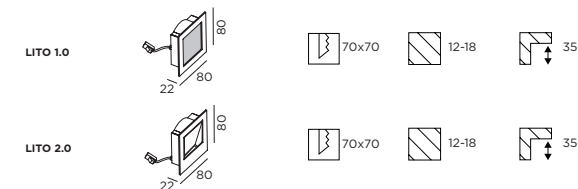

MOUNTING INSTRUCTION

- 1 Make a hole in the wall according to the prescribed dimensions of the fixture or the recessed housing.
- 2 When using a (recessed housing +) plaster kit: Insert the recessed housing into the wall and fix the plaster kit with screws on it. Plaster into the wall.

POWER CONNECTION

- 3 SERIAL CONNECTION - for LED

**Always use POWER SUPPLY
350mA / 500mA**

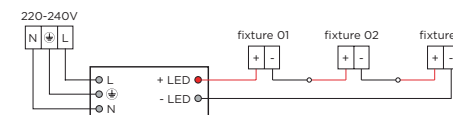

- 4 Insert the fixture in the hole or recessed housing