

## Oita

BY XAVIER SOLÉ

Aplique Wall lamp Applique

### Descripción Description Description

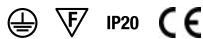

- > OITA es una lámpara clásica de pantalla ovalada, con lector incorporado en su base, de reducidas dimensiones. Su forma básica y elegante permite ubicarse indistintamente en habitaciones de Hoteles o en el hogar.
- > OITA is a classic wall lamp with oval shade and integrated LED reader in the small wall support. Its elegant shape is ideal for the hotel industry as well as for domestic use.
- > OITA est une applique classique avec un abat-jour oval et un lecteur LED intégré sur une petite structure murale. Sa forme élégante est idéale pour le secteur hôtelier tout comme pour le secteur résidentiel.

### Materiales y acabados Materials and finishes Matériaux et finitions

#### Estructura Structure Structure

- > Negro o blanco.
- > Black or white.
- > Noir ou blanc.

#### Pantalla Lampshade Abat-jour

- > Cotonet o screen.
- > Cotonet or screen.
- > Cotonet ou screen.

### Características eléctricas Electrical characteristics Caractéristiques électriques

1 x E-27 LED 12W



LED 3W

150 lm

3.000 K



### Medidas generales General Measures Mesures générales

- > Altura total 20 cm. Foco lector 10,5 cm y diámetro 2,8 cm. Pantalla ovalada 22 x 14 x 18 cm.
- > Total height 20 cm. Led reader 10,5 cm and diameter 2,8 cm. Oval shade 22 x 14 x 18 cm.
- > Hauteur totale 20 cm. Lecteur Led 10,5 cm et diamètre 2,8 cm. Abat-jour oval 22 x 14 x 18 cm.

### Embalaje Packaging Emballage

- > 1 caja
- > 1 box
- > 1 carton



40 x 21 x 20 cm / 0.02 m<sup>3</sup>  
16.1" 8.3" 7.9" / 0.7 ft<sup>3</sup>

### Peso Weight Poids

2 kg  
4.4 lb



### Mantenimiento Maintenance Entretien

- > Limpiar con tela suave ligeramente humedecida con agua. No utilizar detergentes, amoníaco o productos abrasivos.
- > Wipe with a clean soft cloth slightly dampened with water. Do not use ammonia, solvents or abrasive cleaning products.
- > Nettoyage avec un tissu doux légèrement humidifié avec de l'eau. Ne pas utiliser d'ammoniaque, solvants ou autres substances abrasives d'entretien.







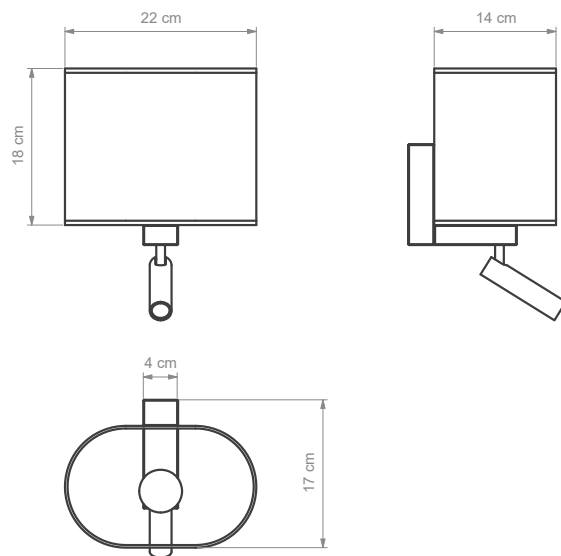

















### Uso Use Usage

- > Interior
- > Indoor
- > Intérieur

### Croquis Sketch Croquis



**Referencias** *References* *Référence*

SIN LECTOR <i>WITHOUT READER</i> SANS LECTEUR	CON LECTOR <i>WITH READER</i> AVEC LECTEUR	ESTRUCTURA <i>STRUCTURE</i> STRUCTURE	PANTALLA <i>LAMP SHADE</i> ABAT-JOUR	SIN LECTOR <i>WITHOUT READER</i> SANS LECTEUR	CON LECTOR <i>WITH READER</i> AVEC LECTEUR	ESTRUCTURA <i>STRUCTURE</i> STRUCTURE	PANTALLA <i>LAMP SHADE</i> ABAT-JOUR
2415	2421	 Negro <i>Black   Noir</i>	 Screen negro <i>Black screen   Screen noir</i>	2427	2433	 Blanco <i>White   Blanc</i>	 Screen negro <i>Black screen   Screen noir</i>
2416	2422	 Negro <i>Black   Noir</i>	 Screen blanco <i>White screen   Screen blanc</i>	2428	2434	 Blanco <i>White   Blanc</i>	 Screen blanco <i>White screen   Screen blanc</i>
2417	2423	 Negro <i>Black   Noir</i>	 Screen beige <i>Beige screen   Screen beige</i>	2429	2435	 Blanco <i>White   Blanc</i>	 Screen beige <i>Beige screen   Screen beige</i>
2418	2424	 Negro <i>Black   Noir</i>	 Cotonet blanco <i>White cot.   Cot. blanc</i>	2430	2436	 Blanco <i>White   Blanc</i>	 Cotonet blanco <i>White cot.   Cot. blanc</i>
2419	2425	 Negro <i>Black   Noir</i>	 Cotonet sand <i>Sand cot.   Cot. sand</i>	2431	2437	 Blanco <i>White   Blanc</i>	 Cotonet sand <i>Sand cot.   Cot. sand</i>
2420	2426	 Negro <i>Black   Noir</i>	 Cotonet negro <i>Black cot.   Cot. noir</i>	2432	2438	 Blanco <i>White   Blanc</i>	 Cotonet negro <i>Black cot.   Cot. noir</i>